

CRP
SERIES



ChemValve-Schmid
Americas

**FLUOROFLOW HIGH PERFORMANCE
PTFE BELLOWS**



Corrosion Resistant Products

CRP has been designing, processing and manufacturing top quality paste extruded PTFE and PFA lined products for more than 35 years. All of our products originate from our manufacturing site near Manchester, UK. Using qualified materials, robust and repeatable manufacturing process technologies and a depth of experience CRP are able to deliver product for the most exacting applications.

Introduction

The FluoroFlow Bellows (FFB) range has been engineered over 40 years to compensate for thermal expansion in pipelines; for the protection of fragile process equipment such as graphite, plastic or glass and the isolation of vibration hazards. PTFE bellows come into their own for corrosive, high purity or hot applications.

CRP has some unique manufacturing processes based upon the use of paste extruded PTFE, and a proprietary convolution process. These have been independently tested by the internationally recognised safety and quality group TÜV, undertaking innovative long term pressure increase testing.

The Product Family

The bellows product range covers 22 sizes from 1"NB to 42"NB. They are manufactured in two materials—virgin PTFE and static dissipating PTFE. FluoroFlow Bellows in sizes 1"NB to 10"NB are available in extra heavy duty only. For larger diameters there is a choice of two wall thicknesses—a heavy duty (HD) and extra heavy duty (XHD). The bellows can be manufactured with 2 to 10 convolutions. However, this is just the standard product. The flexibility of the manufacturing method is such that many special configurations can be produced to meet specific customer requirements.

For products requiring a higher pressure rating than is possible with PTFE alone, we have our range of armoured bellows (FFAB) where the PTFE is surrounded by a high pressure stainless steel shell.

HiPerFlon® (Molecular Enhanced)

HiPerFlon® is a second generation paste extruded High Performance PTFE. HiPerFlon® has the greatest

mechanical properties and lowest permeation rates of PTFE materials and as such provides high pressure ratings, long lifetime, low maintenance costs and consequently the lowest cost of ownership.

The Manufacturing Process

CRP uses virgin paste extruded or virgin multi-ply PTFE tubes of their own manufacture to guarantee the highest quality from the beginning of the production process. A unique convolution process undertaken at very high temperatures, combined with additional material to compensate for the extra length from straight to convoluted, provides a uniform PTFE wall thickness and a stress-free material in a thermally locked bellows shape. This process has a significant influence on product lifetime performance.



Bellows Design and Type Testing

A key consideration in bellows performance is the temperature and pressure that the bellows will withstand for extended periods of time. There are no ASME, DIN or other global standards for bellows design. Most of CRP's competitors just use a simple burst pressure test at ambient temperature to create the comprehensive pressure / temperature curves in their catalogues, sometimes with a safety factor of less than 3.

A safety factor is defined as the ratio of burst pressure to allowable operating pressure. Bursting pressure tests, although a key indicator, cannot fully define a bellows performance as a burst pressure test has a duration of 10 to 20 seconds and is unable to replicate the effect of deformation of the bellows through creep.

Therefore CRP has developed a much more comprehensive approach to testing as follows:

Bursting Pressure Test

Bursting pressure tests are used only for the determination of pressure rating at ambient (32°F) temperature. At this temperature CRP has adopted a safety factor of 6 for bellows up to 8"NB and a safety factor of 4 for the larger diameters.

Pressure Increase Test

In addition to the bursting pressure tests, innovative pressure increase tests have been undertaken successfully at 212°F, 302°F and 400°F by TÜV. These unforgiving tests slowly increase the delivered pressure to the bellows at high temperatures, encouraging the PTFE material to flow and creep as in service. The pressure increase test results confirm the outstanding creep resistance of the FluoroFlow Bellows provided by the unique convolution process.

Internal Pressure Long Term Creep Test

FluoroFlow Bellows have passed successfully an Internal Pressure Creep Test (similar to EN ISO 9080) by TÜV at 302°F. 14 Bellows have been tested in total and two bellows remained under pressure at 302°F in the oven for one year. This confirms the long term creep resistance even at high temperatures and pressures.

Lifetime Assurance

Based on the pressure / temperature limits from these tests, CRP has determined the pressure / temperature curves for the FluoroFlow Bellows to have a residual safety factor of 2 after more than 10 years in operation.

International Standards

All bellows, comply with the Pressure Equipment Directive 2014/68/EU (PED) and the Pressure Equipment (Safety) regulations 2016 (PE(S)R), they are CE / UKCA marked where appropriate, and are provided with CE / UKCA Declaration of Conformity. PTFE armoured bellows for high pressure performance are designed according to the Expansion Joint Manufacturers Association (EJMA) international standard. The business is third party accredited to ISO9001:2015.

Product Testing

Bellows materials are fully traceable. Bellows tubes undergo mechanical and dimensional tests following manufacture. PTFE sintering and convoluting are undertaken using calibrated ovens with precise temperature control. Independent process checks are undertaken using infra-red thermometry. In-process visual inspection of the PTFE tubes is undertaken and this combined with a hydrostatic test and further visual inspection of the finished product completes the product verification. Certification is available if required to reassure the customer on materials of construction, process control and product testing.

Operating Temperatures

The standard operating envelope for the product is 32°F to 400°F, but with selection of different flange materials the bellows can be supplied for temperatures outside this envelope.

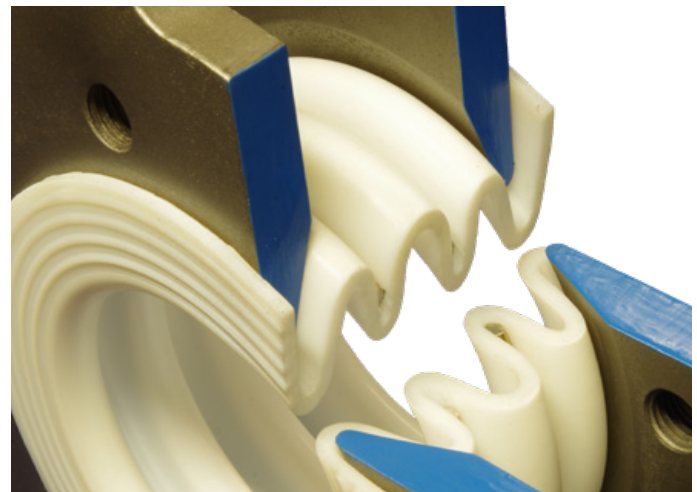

Special Bellows

Many customized bellows are available, including bellows with extended flares, reducing bellows (different flange sizes), different flange types, hinged bellows, lateral bellows, dual containment bellows, bellows with special neutral lengths and bellows with special PTFE wall thicknesses.

Internal vacuum support rings can be provided in exotic metals or PTFE lined and the bellows flanges can be manufactured in other metals. Bellows with electrically isolating tie rods are also available.

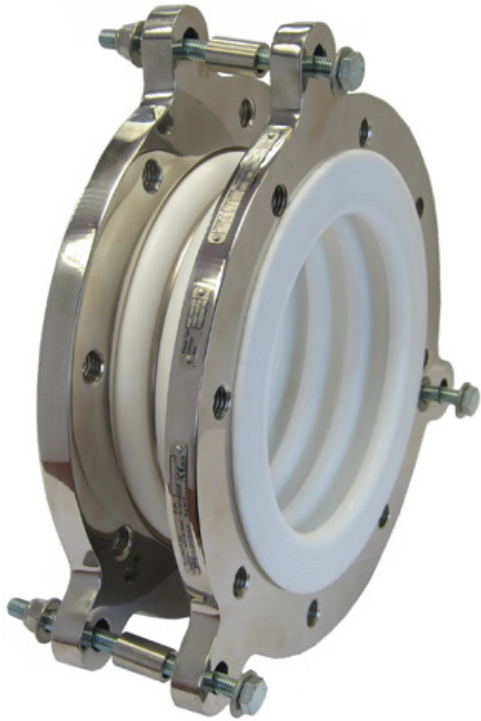

PTFE Bellows with stainless steel flanges

Safety Shields

Following guidance from the European Pressure Equipment Directive 2014/68/EU and international insurers, we strongly recommend the use of Safety Shields around each bellows.

Because of its nature, the bellows is the weakest part of a piping system and safety shields can assist in mitigating risk to operators and the environment.



Glassfibre Coated PTFE shield with FEP Window

Smoothbore Sleeves

If handling media at high velocities or with entrained solids we suggest you consider using smoothbore sleeves. These are manufactured from PTFE and provide additional protection to the bellows for abrasive duties as well as minimising the potential build up of solids in the convolutions. As standard these are supplied as a loose fit to avoid the sleeve constraining the bellows movement. However a tight fit is also available. As standard the sleeve is sized to protrude just beyond the end of the bellows when it is at maximum axial length, but this can be specified at the time of order.



Design and Piping Layout

Prior to specifying the bellows it is necessary to produce a piping layout with correct pipe supports and an exact specification of the expected movements, irrespective of whether they are to be used for thermal compensation or the protection of fragile equipment made of glass or graphite. Bellows cannot support forces either from the weight of the piping components or from the liquid inside the pipes.

Effective Area and Spring Rates

The effective area and the spring rates have a significant influence upon the stress calculations for the piping system. Please find the relevant data on the following pages for each bellows size. For the influence of temperature upon spring rates please use the conversion table on the next page.

Temperature Correction Factors (TCF)	
°F	TCF
68°	1.00
176°	0.65
248°	0.50
302°	0.40
404°	0.30

For example: To calculate the spring rate @ 248°F take the spring rate @68°F and multiply by 0.5.

Operating and Installation Instructions

A comprehensive user manual is packed with the bellows shipment. These instructions can also be downloaded from our website (www.crp-us.com) or can be sent out by email (enquiry@crp-us.com). It is critical that these are referred to for the correct installation of bellows.



Key Product Features

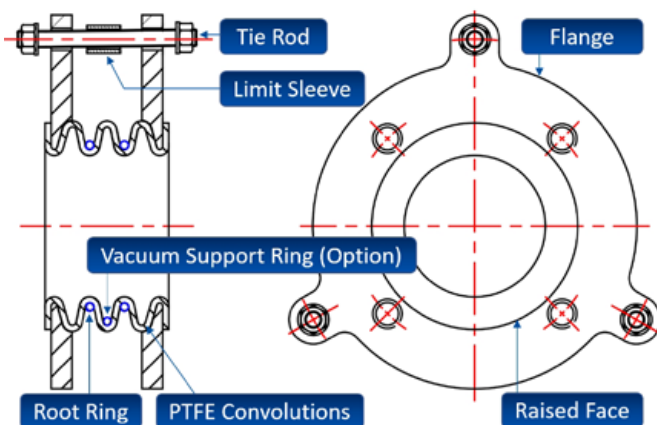

Flanges

Bellows flanges are available to all of the international flange standards including ASME Class 150 and 300 and DIN PN 10 and 16. As standard the flange bolt holes are drilled and tapped either UNC for ASME or Metric Series for DIN. Flanges are painted in an ultra high temperature paint in a silver finish. It is worth noting the internal flange profiling that assists the first convolution in minimising any stress generated by the flange.

PTFE Convolutions

The number of convolutions is key to the range of movement provided by the bellows — the more convolutions the greater the range of movement. However the compromise is that both pressure and vacuum performance are reduced as the number of convolutions increases.

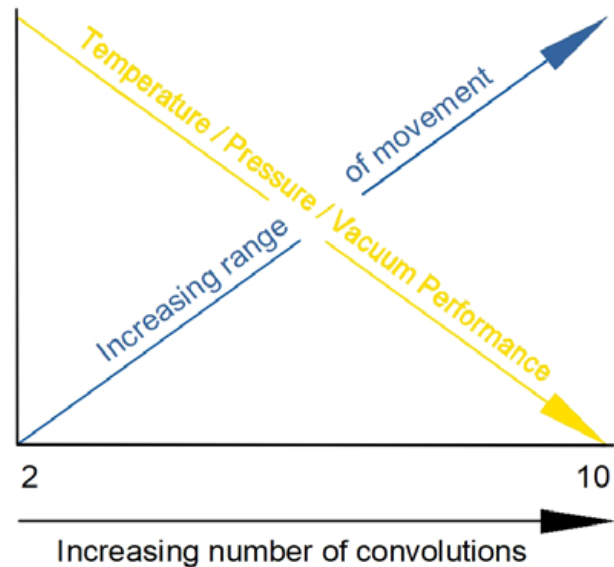

In sizes above 10”NB there is the option of Heavy Duty (HD) or Extra Heavy Duty (XHD) Bellows. The additional wall thickness of the XHD product provides an improved temperature and pressure range. Up to 10”NB, XHD is the standard liner we produce bellows from.

The number of convolutions is key to the range of movement provided by the bellows—the more convolutions the greater the range of movement. However the compromise is that both pressure and vacuum performance are reduced as the number of convolutions.

Root Rings

Root rings serve to provide support for the PTFE which is a mechanically weak material especially when hot. These sit at the base of each convolution. These are supplied in stainless steel as standard, but can be manufactured in exotic metals where required—for example to avoid the potential for stress corrosion cracking in hydrochloric acid service.

Tie Rods

These prevent the bellows from exceeding their maximum allowed movements. They arrive factory set at the maximum allowable extension as detailed on the data label. The tie rods have been sized to cope with the maximum pressure thrust that can result from internal pressure in the bellows, both in operation and during test. However, tie rods are not designed to cope with external loads applied to the bellows by the adjacent pipe work due to circumstances such as pipework misalignment, failure of anchors etc.

Limit Sleeves

These prevent damage to the convolutions by preventing the bellows from being compressed below the minimum allowable axial length.

Anti-Snake Rings

When the number of convolutions exceeds five we would recommend one or more Anti-snake rings. These are mounted on the outside of the bellows, replacing and serving the role of the root ring, but also tying into the tie rod to prevent the bellows squirring under high temperatures and pressures.



Vacuum Support Rings

Internal vacuum support rings are available for larger bellows where they have a low or no vacuum performance. They will enable the bellows to perform under full vacuum. These rings fit inside the bellows convolutions, so are exposed to the process. They are available either PTFE encapsulated on the outside, or in various exotic metals. They may reduce bellows movements, so please consult with us.

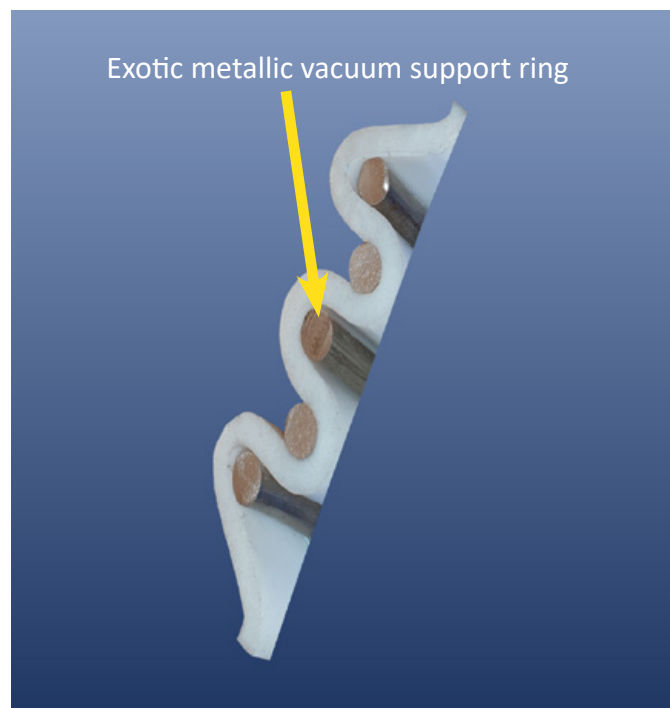

Data Labels

There are three or four data labels riveted to the bellows flanges to carry as much information about the bellows as practical.

However, more information is available in this catalogue, or by reference to CRP, quoting the part number and serial number references.



Identification Nameplate

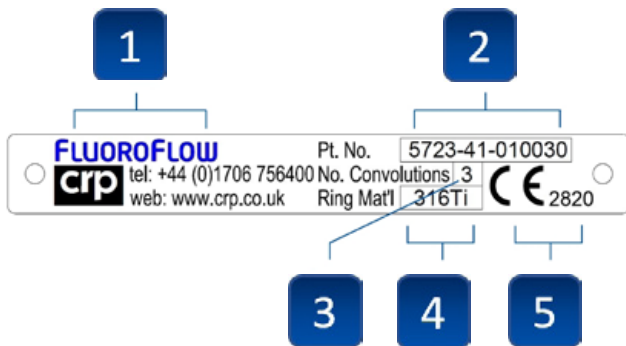

1. The product family is referred to as FluoroFlow Bellows or “FFB”.
2. The CRP part number.
3. The number of convolutions.
4. The material used for the root rings.
5. Our CE mark and notified body number for compliance with the PED (Pressure Equipment Directive).

Flange Drillings Nameplate

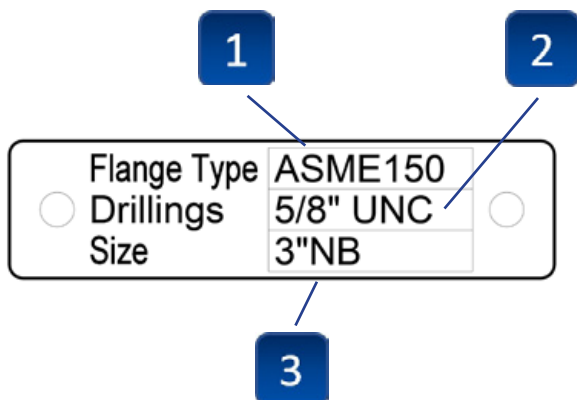

If the flanges are identical there will be one of these labels. However should the flanges be dissimilar, there will be a label on each flange.

1. The flange type.
2. The size and thread type for the drillings.
3. The bellows nominal size or in the case of reducing bellows, the flange size at each end.

Operating Parameters Nameplate

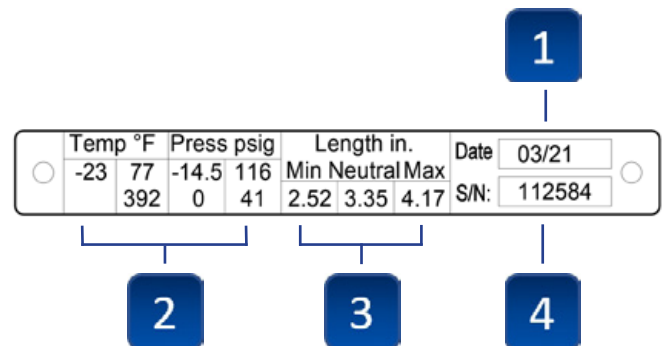

1. The month and year of manufacture.
2. Two rows of temperature and pressure information. In this example showing the performance at -23°F to 77°F (-14.5 up to 116 PSI) and 392°F (0 up to 41 PSI). There is not always enough room to show the maximum temperature which can cope with full vacuum, nor provide intermediate data. Reference to the data sheets in this catalogue can provide more information.
3. The minimum, neutral and maximum lengths for axial travel.
4. A unique serial number for the item.

Explanation of Movements

A key attribute of bellows is their ability to move in response to stresses placed upon them by the equipment to which they are mounted, whether such stresses are generated by expansion and contraction or plant vibration.

There are three directions of movement for which a bellows is designed; axial, lateral and angular. Please note that bellows are not designed for rotational movement around the principal axis.

The allowable movements are dependent upon nominal bore and number of convolutions and are provided on the following individual product nominal bore pages. It is important to understand that these movements are not independent.

Combined Movements

When calculating maximum combined movements consider the total allowable in all three directions as comprising 100%. This 100% can be apportioned

across the three movement types. For instance if a bellows were installed at an axial length utilising 50% of the allowable axial movement of the bellows and there were no angular movement, only 50% of the published lateral movement would be remaining within the safe movement limits with these concurrent movements. If 25% of the maximum allowable angular movement was utilised concurrently with 50% of the axial movement then only 25% of the lateral movement would be remaining.

Axial

This is the most frequently required type of movement and is specified in terms of the bellows minimum and maximum extension and its neutral length. The neutral length is the mid-range position of the bellows. Bellows can be installed at lengths between the minimum and maximum length, but this of course will restrict the amount of allowable movement. CRP Bellows do not require restraining to hold their neutral length and are delivered with the flanges sitting at their neutral length with the tie rods set to their maximum extension.

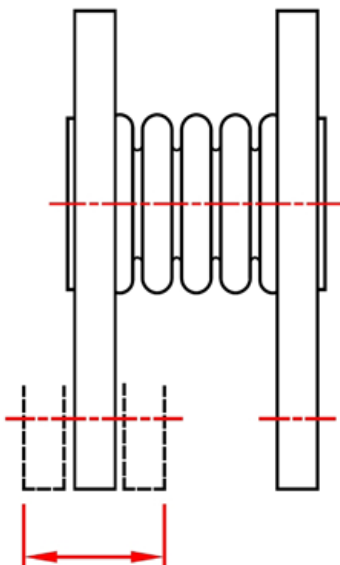

Axial Only Bellows

Lateral

Lateral movement is movement at right angles to the principal axis.

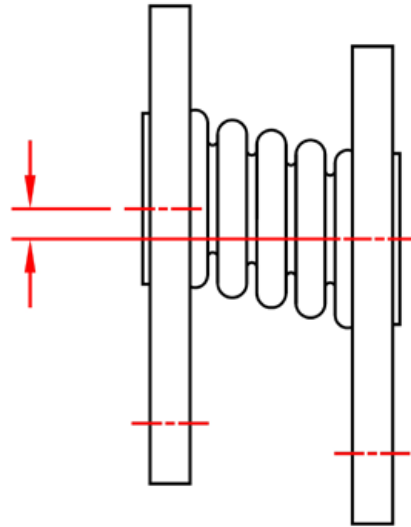

Angular

Angular movement is the movement of the flanges out of parallel.

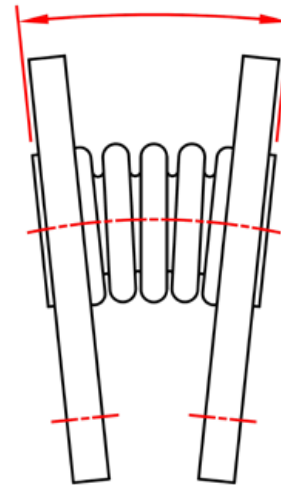

Modified Movement Bellows

The mechanical design of the flanges, tie rods and limit sleeves are to restrict bellows movement within their safe range. However, it may be necessary to change movement still further, such as preventing movement in one or more planes, focus all movement in one plane or create additional movement. Special bellows are available for these purposes.

Axial Only Bellows [Axial Bellows]

By providing an external frame with guide rods, the bellows can be restricted to axial movement only.

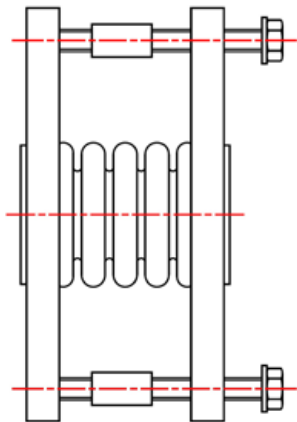

Movement	Possible
Axial	✓
Lateral	no
Angular	no

Lateral Only Bellows [Lateral Bellows]

Tie rods with special spherical washers capturing the flange face allow movement in any lateral plane.

Movement	Possible
Axial	no
Lateral (any plane)	✓
Angular	no

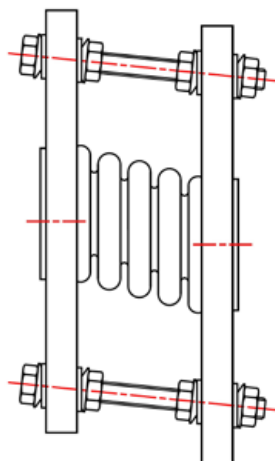

One Plane Angular Bellows [Hinged Bellows]

Hinged bellows allow angular movement only in one plane, thereby maximising the angular range.

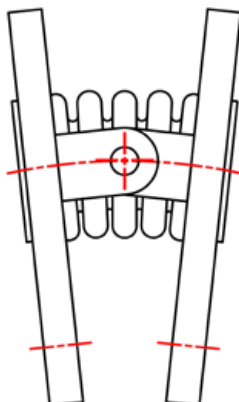

Movement	Possible
Axial	no
Lateral	no
Angular (one plane)	✓

All Planes Angular Bellows [Gimballed Bellows]

As with the hinged bellows they allow only angular movements, but with the addition of gimbals enables angular movement in any plane.

Movement	Possible
Axial	no
Lateral	no
Angular (any plane)	✓

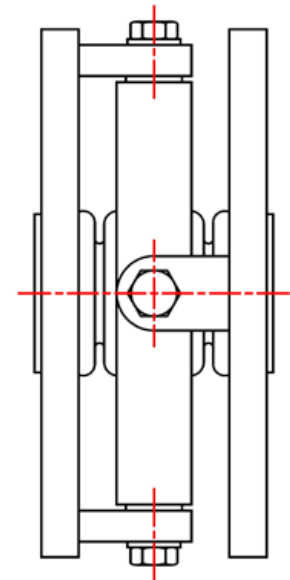

Large Movement Lateral Bellows [Universal Bellows]

An arrangement of two bellows incorporating a short PTFE lined pipe spool provides a large amount of lateral movement by effectively converting each bellows into an angular bellows.

Movement	Possible
Axial	✓
Large Lateral	✓
Angular	✓

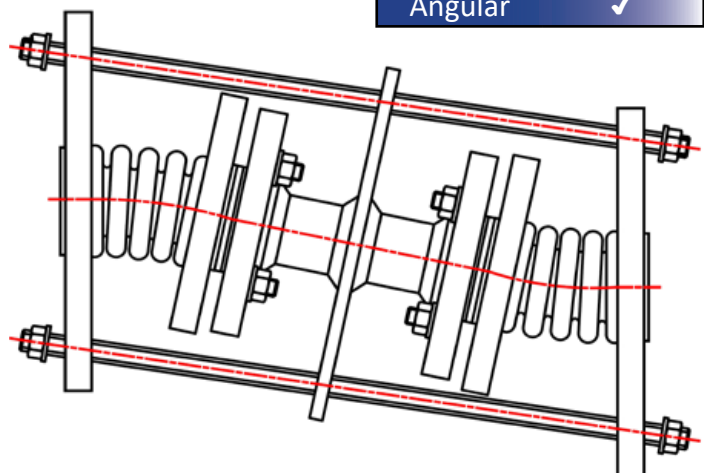

FluoroFlow FFB PTFE Bellows are manufactured from virgin or static dissipating paste extruded HiPerFlon® PTFE. They are manufactured using a unique process which ensures a uniform PTFE wall thickness and eliminates stress in the PTFE from the convolution process. These bellows have an Extra Heavy Duty "XHD" liner.

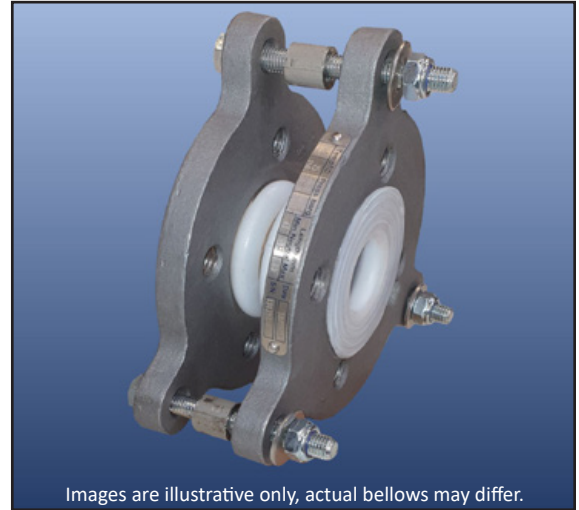
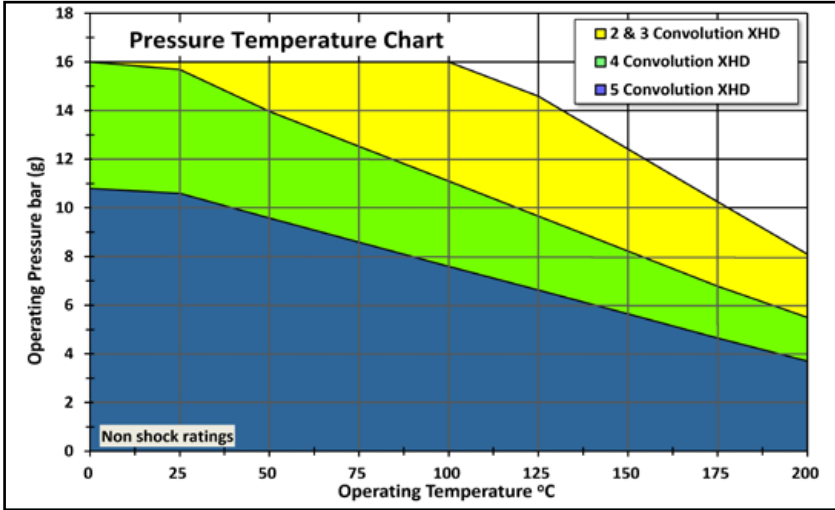

Dimensions and Movements ¹						Weight
Convolutions ⁴	Neutral Length [Inches]	Minimum Length [Inches]	Maximum Length [Inches]	Lateral +/- [Inches]	Angular +/- [degrees]	[lbs]
FFB 2	1.69	1.42	1.97	0.16	6	4.4
FFB 3	2.13	1.69	2.56	0.24	10	4.4
FFB 4	2.56	1.97	3.15	0.31	13	4.4
FFB 5	3.00	2.24	3.74	0.39	17	4.4

Spring Rates ² @ 68°F +/- 50%			
Axial Compression [lb / 1/8"]	Axial Extension [lb / 1/8"]	Lateral [lb / 1/8"]	Angular [inch-lbs / °]
173	57	49	4
115	38	33	3
86	29	25	2
69	23	20	2

Materials	
Component	Materials
Bellows	Paste Extruded Virgin PTFE to ASTM D4895
Flanges	Carbon Steel to BS1501-161-430A / P265GH Typical
Paint	Ultra-High Temperature in Silver
Root Rings	Stainless Steel to 320S31 (316Ti)
Tie Rods & Nuts	Carbon Steel Grade 8.8 Zinc Plated
Limit Sleeves	Stainless Steel to ASTM A312 Gr. 304/304L

Flanges	
	ASME Class 150
Raised Face Ø	2.0"
Bolt Circle Ø	3.12"
Flange Ø max	6.57"
Bolt Holes ³ [No x Thread]	4 x 1/2" UNC
Thickness	0.47"
Effective Area	1.6" ²

Options	
Component	Options
Bellows	Paste Extruded Static-Dissipating ASTM D4895
Flanges	Stainless Steel, Hastelloy, Low Temperature Steels etc.
Root Rings	Hastelloy, Monel etc.
Tie Rods & Nuts	Stainless Steel, Hastelloy, Monel etc.
Anti-Snake Rings	Stainless Steel

Vacuum Performance PSI (g)				
Model	68°F	212°F	300°F	400°F
FFB 2 XHD	Full vac.	Full vac.	Full vac.	Full vac.
FFB 3 XHD	Full vac.	Full vac.	Full vac.	Full vac.
FFB 4 XHD	Full vac.	Full vac.	Full vac.	Full vac.
FFB 5 XHD	Full vac.	Full vac.	Full vac.	Full vac.

Notes:

1. Larger movements are available with more convolutions if required. These are not combined movements please refer to page 7.
2. Please refer to page 5 for temperature correction factors for spring rate.
3. As standard flange holes are threaded. Clearance holes are possible for certain sizes please contact us.
4. The maximum number of convolutions for this size is 10, please consult us for further information on these.
5. For operating temperature and pressure for more than 5 convolutions please contact us.

FluoroFlow FFB PTFE Bellows are manufactured from virgin or static dissipating paste extruded HiPerFlon® PTFE. They are manufactured using a unique process which ensures a uniform PTFE wall thickness and eliminates stress in the PTFE from the convolution process. These bellows have an Extra Heavy Duty "XHD" liner.

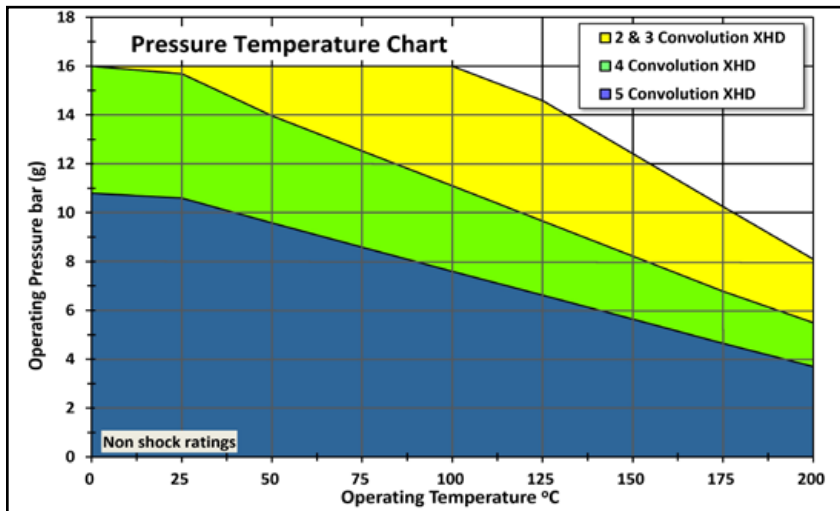

Dimensions and Movements ¹						Weight
Convolutions ⁴	Neutral Length [Inches]	Minimum Length [Inches]	Maximum Length [Inches]	Lateral +/- [Inches]	Angular +/- [degrees]	[lbs]
FFB 2	1.69	1.42	1.97	0.16	6	4.4
FFB 3	2.13	1.69	2.56	0.24	10	4.4
FFB 4	2.56	1.97	3.15	0.31	13	4.4
FFB 5	3.00	2.24	3.74	0.39	17	4.4

Spring Rates ² @ 68°F +/- 50%			
Axial Compression [lb / 1/8"]	Axial Extension [lb / 1/8"]	Lateral [lb / 1/8"]	Angular [inch-lbs / °]
173	57	49	4
115	38	33	3
86	29	25	2
69	23	20	2

Materials	
Component	Materials
Bellows	Paste Extruded Virgin PTFE to ASTM D4895
Flanges	Carbon Steel to BS1501-161-430A / P265GH Typical
Paint	Ultra-High Temperature in Silver
Root Rings	Stainless Steel to 320S31 (316Ti)
Tie Rods & Nuts	Carbon Steel Grade 8.8 Zinc Plated
Limit Sleeves	Stainless Steel to ASTM A312 Gr. 304/304L

Flanges	
	ASME Class 150
Raised Face Ø	2.5"
Bolt Circle Ø	3.5"
Flange Ø max	6.57"
Bolt Holes ³ [No x Thread]	4 x 1/2" UNC
Thickness	0.47"
Effective Area	1.6" ²

Options	
Bellows	Paste Extruded Static-Dissipating ASTM D4895
Flanges	Stainless Steel, Hastelloy, Low Temperature Steels etc.
Root Rings	Hastelloy, Monel etc.
Tie Rods & Nuts	Stainless Steel, Hastelloy, Monel etc.
Anti-Snake Rings	Stainless Steel

Vacuum Performance PSI (g)				
Model	68°F	212°F	300°F	400°F
FFB 2 XHD	Full vac.	Full vac.	Full vac.	Full vac.
FFB 3 XHD	Full vac.	Full vac.	Full vac.	Full vac.
FFB 4 XHD	Full vac.	Full vac.	Full vac.	Full vac.
FFB 5 XHD	Full vac.	Full vac.	Full vac.	Full vac.

Notes:

- Larger movements are available with more convolutions if required. These are not combined movements please refer to page 7.
- Please refer to page 5 for temperature correction factors for spring rate.
- As standard flange holes are threaded. Clearance holes are possible for certain sizes please contact us.
- The maximum number of convolutions for this size is 10, please consult us for further information on these.
- For operating temperature and pressure for more than 5 convolutions please contact us.

FluoroFlow FFB PTFE Bellows are manufactured from virgin or static dissipating paste extruded HiPerFlon® PTFE. They are manufactured using a unique process which ensures a uniform PTFE wall thickness and eliminates stress in the PTFE from the convolution process. These bellows have an Extra Heavy Duty "XHD" liner.

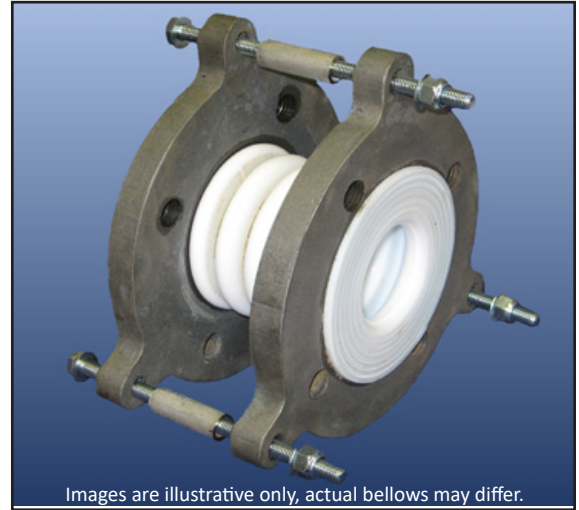
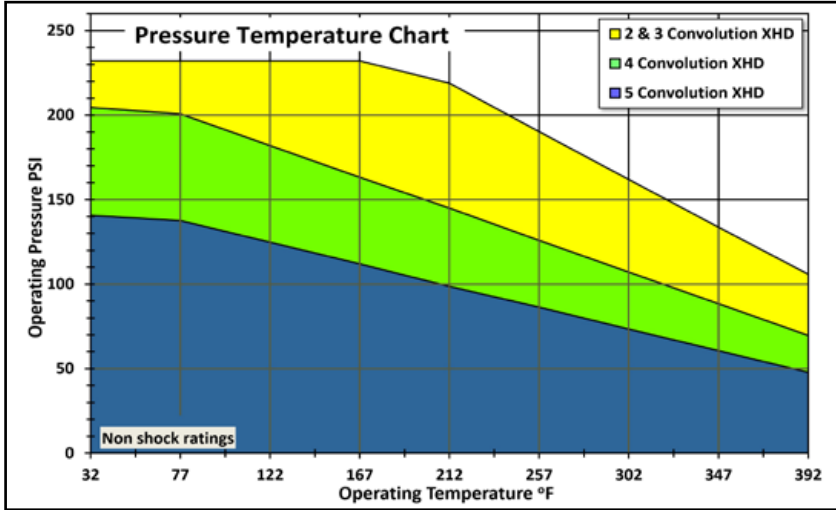

Dimensions and Movements ¹						Weight
Convolutions ⁴	Neutral Length [Inches]	Minimum Length [Inches]	Maximum Length [Inches]	Lateral +/- [Inches]	Angular +/- [degrees]	[lbs]
FFB 2	2.13	1.81	2.44	0.16	6	11
FFB 3	2.72	2.20	3.23	0.24	10	11
FFB 4	3.31	2.60	4.02	0.31	13	11
FFB 5	3.90	2.99	4.80	0.47	17	11

Spring Rates ² @ 68°F +/- 50%			
Axial Compression [lb/1/8"]	Axial Extension [lb/1/8"]	Lateral [lb/1/8"]	Angular [" lbf / °]
236	83	96	12
157	55	64	8
118	41	49	6
94	33	39	4

Materials	
Component	Materials
Bellows	Paste Extruded Virgin PTFE to ASTM D4895
Flanges	Carbon Steel to BS1501-161-430A / P265GH Typical
Paint	Ultra-High Temperature in Silver
Root Rings	Stainless Steel to 320S31 (316Ti)
Tie Rods & Nuts	Carbon Steel Grade 8.8 Zinc Plated
Limit Sleeves	Stainless Steel to ASTM A312 Gr. 304/304L

Flanges	
	ASME Class 150
Raised Face Ø	2.88"
Bolt Circle Ø	3.88"
Flange Ø max	8.03"
Bolt Holes ³ [No x Thread]	4 x 1/2" UNC
Thickness	0.62"
Effective Area	3.4" ²

Options	
Component	Options
Bellows	Paste Extruded Static-Dissipating ASTM D4895
Flanges	Stainless Steel, Hastelloy, Low Temperature Steels etc.
Root Rings	Hastelloy, Monel etc.
Tie Rods & Nuts	Stainless Steel, Hastelloy, Monel etc.
Anti-Snake Rings	Stainless Steel

Vacuum Performance PSI (g)				
Model	68°F	212°F	300°F	400°F
FFB 2 XHD	Full vac.	Full vac.	Full vac.	Full vac.
FFB 3 XHD	Full vac.	Full vac.	Full vac.	Full vac.
FFB 4 XHD	Full vac.	Full vac.	Full vac.	Full vac.
FFB 5 XHD	Full vac.	Full vac.	Full vac.	Full vac.

Notes:

- Larger movements are available with more convolutions if required. These are not combined movements please refer to page 7.
- Please refer to page 5 for temperature correction factors for spring rate.
- As standard flange holes are threaded. Clearance holes are possible for certain sizes please contact us.
- The maximum number of convolutions for this size is 10, please consult us for further information on these.
- For operating temperature and pressure for more than 5 convolutions please contact us.

FluoroFlow FFB PTFE Bellows are manufactured from virgin or static dissipating paste extruded HiPerFlon® PTFE. They are manufactured using a unique process which ensures a uniform PTFE wall thickness and eliminates stress in the PTFE from the convolution process. These bellows have an Extra Heavy Duty "XHD" liner.

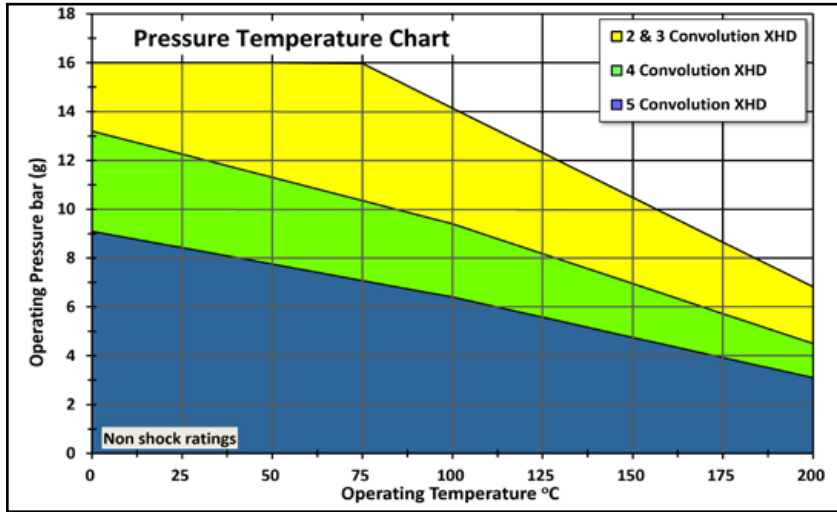

Dimensions and Movements ¹						Weight
Convolutions ⁴	Neutral Length [Inches]	Minimum Length [Inches]	Maximum Length [Inches]	Lateral +/- [Inches]	Angular +/- [degrees]	[lbs]
FFB 2	2.17	1.73	2.60	0.24	7	11
FFB 3	2.76	2.13	3.39	0.35	11	11
FFB 4	3.35	2.52	4.17	0.47	14	11
FFB 5	3.94	2.91	4.96	0.59	18	13

Spring Rates ² @ 68°F +/- 50%			
Axial Compression [lb / 1/8"]	Axial Extension [lb / 1/8"]	Lateral [lb / 1/8"]	Angular [inch-lbs / °]
283	96	203	21
188	64	136	14
141	49	102	11
113	39	81	8

Materials	
Component	Materials
Bellows	Paste Extruded Virgin PTFE to ASTM D4895
Flanges	Carbon Steel to BS1501-161-430A / P265GH Typical
Paint	Ultra-High Temperature in Silver
Root Rings	Stainless Steel to 320S31 (316Ti)
Tie Rods & Nuts	Carbon Steel Grade 8.8 Zinc Plated
Limit Sleeves	Stainless Steel to ASTM A312 Gr. 304/304L

Flanges	
	ASME Class 150
Raised Face Ø	3.62"
Bolt Circle Ø	4.75"
Flange Ø max	8.66"
Bolt Holes ³ [No x Thread]	4 x 5/8" UNC
Thickness	0.62"
Effective Area	5.0" ²

Options	
Bellows	Paste Extruded Static-Dissipating ASTM D4895
Flanges	Stainless Steel, Hastelloy, Low Temperature Steels etc.
Root Rings	Hastelloy, Monel etc.
Tie Rods & Nuts	Stainless Steel, Hastelloy, Monel etc.
Anti-Snake Rings	Stainless Steel

Vacuum Performance PSI (g)				
Model	68°F	212°F	300°F	400°F
FFB 2 XHD	Full vac.	Full vac.	Full vac.	Full vac.
FFB 3 XHD	Full vac.	Full vac.	Full vac.	Full vac.
FFB 4 XHD	Full vac.	Full vac.	Full vac.	Full vac.
FFB 5 XHD	Full vac.	Full vac.	Full vac.	Full vac.

Notes:

- Larger movements are available with more convolutions if required. These are not combined movements please refer to page 7.
- Please refer to page 5 for temperature correction factors for spring rate.
- As standard flange holes are threaded. Clearance holes are possible for certain sizes please contact us.
- The maximum number of convolutions for this size is 10, please consult us for further information on these.
- For operating temperature and pressure for more than 5 convolutions please contact us.

FluoroFlow FFB PTFE Bellows are manufactured from virgin or static dissipating paste extruded HiPerFlon® PTFE. They are manufactured using a unique process which ensures a uniform PTFE wall thickness and eliminates stress in the PTFE from the convolution process. These bellows have an Extra Heavy Duty "XHD" liner.

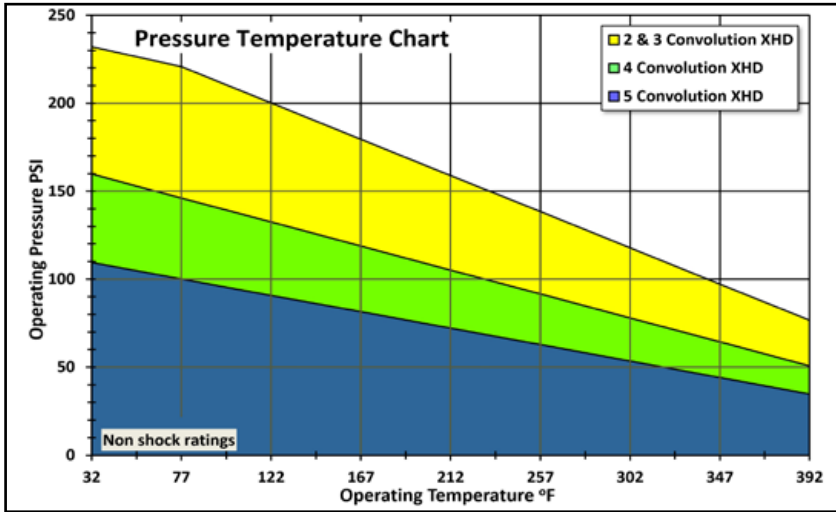

Dimensions and Movements ¹						Weight
Convolutions ⁴	Neutral Length [Inches]	Minimum Length [Inches]	Maximum Length [Inches]	Lateral +/- [Inches]	Angular +/- [degrees]	[lbs]
FFB 2	2.56	2.13	2.99	0.24	7	13
FFB 3	3.35	2.72	3.98	0.35	10	13
FFB 4	4.13	3.31	4.96	0.47	13	15
FFB 5	4.92	3.90	5.94	0.59	16	15

Spring Rates ² @ 68°F +/- 50%			
Axial Compression [lb / 1/8"]	Axial Extension [lb / 1/8"]	Lateral [lb / 1/8"]	Angular [inch-lbs / °]
300	96	175	35
200	64	116	24
150	48	87	18
120	38	70	14

Materials	
Component	Materials
Bellows	Paste Extruded Virgin PTFE to ASTM D4895
Flanges	Carbon Steel to BS1501-161-430A / P265GH Typical
Paint	Ultra-High Temperature in Silver
Root Rings	Stainless Steel to 320S31 (316Ti)
Tie Rods & Nuts	Carbon Steel Grade 8.8 Zinc Plated
Limit Sleeves	Stainless Steel to ASTM A312 Gr. 304/304L

Flanges	
	ASME Class 150
Raised Face Ø	4.12"
Bolt Circle Ø	5.50"
Flange Ø max	9.44"
Bolt Holes ³ [No x Thread]	4 x 5/8" UNC
Thickness	0.62"
Effective Area	8.1" ²

Options	
Component	Options
Bellows	Paste Extruded Static-Dissipating ASTM D4895
Flanges	Stainless Steel, Hastelloy, Low Temperature Steels etc.
Root Rings	Hastelloy, Monel etc.
Tie Rods & Nuts	Stainless Steel, Hastelloy, Monel etc.
Anti-Snake Rings	Stainless Steel

Vacuum Performance PSI (g)				
Model	68°F	212°F	300°F	400°F
FFB 2 XHD	Full vac.	Full vac.	Full vac.	Full vac.
FFB 3 XHD	Full vac.	Full vac.	Full vac.	Full vac.
FFB 4 XHD	Full vac.	Full vac.	Full vac.	Full vac.
FFB 5 XHD	Full vac.	Full vac.	Full vac.	Full vac.

Notes:

1. Larger movements are available with more convolutions if required. These are not combined movements please refer to page 7.
2. Please refer to page 5 for temperature correction factors for spring rate.
3. As standard flange holes are threaded. Clearance holes are possible for certain sizes please contact us.
4. The maximum number of convolutions for this size is 10, please consult us for further information on these.
5. For operating temperature and pressure for more than 5 convolutions please contact us.

FluoroFlow FFB PTFE Bellows are manufactured from virgin or static dissipating paste extruded HiPerFlon® PTFE. They are manufactured using a unique process which ensures a uniform PTFE wall thickness and eliminates stress in the PTFE from the convolution process. These bellows have an Extra Heavy Duty "XHD" liner.

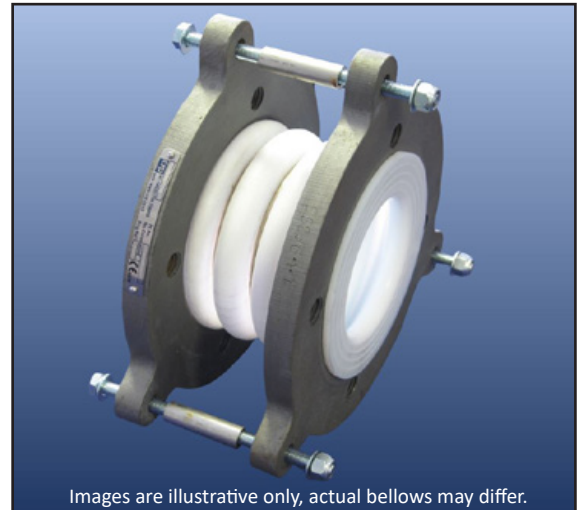
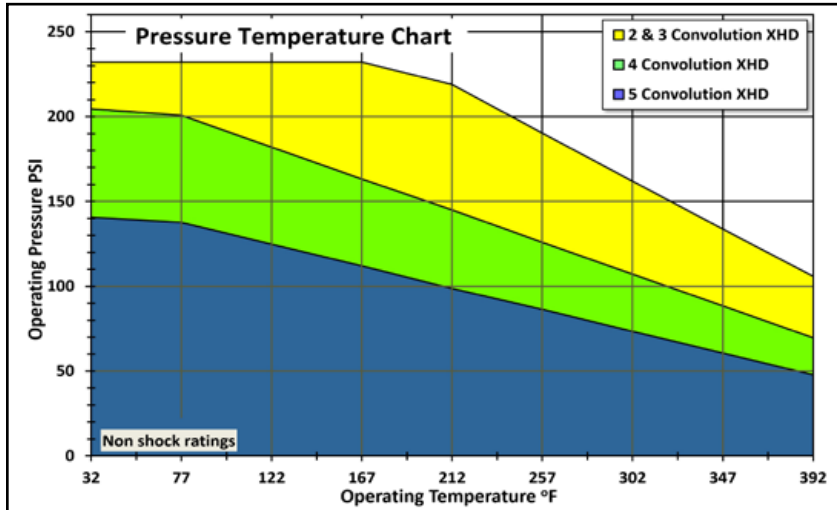

Dimensions and Movements ¹						Weight
Convolutions ⁴	Neutral Length [Inches]	Minimum Length [Inches]	Maximum Length [Inches]	Lateral +/- [Inches]	Angular +/- [degrees]	[lbs]
FFB 2	2.56	2.05	3.07	0.28	7	15
FFB 3	3.35	2.60	4.09	0.43	11	18
FFB 4	4.13	3.19	5.08	0.59	14	18
FFB5	4.92	3.74	6.10	0.75	18	18

Spring Rates ² @ 68°F +/- 50%			
Axial Compression [lb/1/8"]	Axial Extension [lb/1/8"]	Lateral [lb/1/8"]	Angular [" lbf / °]
332	92	196	53
221	61	131	35
166	46	98	27
133	37	79	21

Materials	
Component	Materials
Bellows	Paste Extruded Virgin PTFE to ASTM D4895
Flanges	Carbon Steel to BS1501-161-430A / P265GH Typical
Paint	Ultra-High Temperature in Silver
Root Rings	Stainless Steel to 320S31 (316Ti)
Tie Rods & Nuts	Carbon Steel Grade 8.8 Zinc Plated
Limit Sleeves	Stainless Steel to ASTM A312 Gr. 304/304L

Flanges	
	ASME Class 150
Raised Face Ø	5.00"
Bolt Circle Ø	6.00"
Flange Ø max	10.23"
Bolt Holes ³ [No x Thread]	4 x 5/8" UNC
Thickness	0.62"
Effective Area	11.3" ²

Options	
Bellows	Paste Extruded Static-Dissipating ASTM D4895
Flanges	Stainless Steel, Hastelloy, Low Temperature Steels etc.
Root Rings	Hastelloy, Monel etc.
Tie Rods & Nuts	Stainless Steel, Hastelloy, Monel etc.
Anti-Snake Rings	Stainless Steel

Vacuum Performance PSI (g)				
Model	68°F	212°F	300°F	400°F
FFB 2 XHD	Full vac.	Full vac.	Full vac.	Full vac.
FFB 3 XHD	Full vac.	Full vac.	Full vac.	Full vac.
FFB 4 XHD	Full vac.	Full vac.	Full vac.	Full vac.
FFB 5 XHD	Full vac.	Full vac.	Full vac.	Full vac.

- Notes:
- Larger movements are available with more convolutions if required. These are not combined movements please refer to page 7.
 - Please refer to page 5 for temperature correction factors for spring rate.
 - As standard flange holes are threaded. Clearance holes are possible for certain sizes please contact us.
 - The maximum number of convolutions for this size is 10, please consult us for further information on these.
 - For operating temperature and pressure for more than 5 convolutions please contact us.

FluoroFlow FFB PTFE Bellows are manufactured from virgin or static dissipating paste extruded HiPerFlon® PTFE. They are manufactured using a unique process which ensures a uniform PTFE wall thickness and eliminates stress in the PTFE from the convolution process. These bellows have an Extra Heavy Duty "XHD" liner.

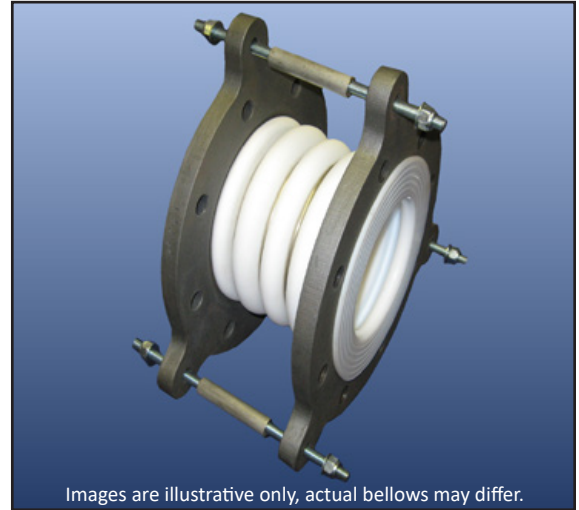
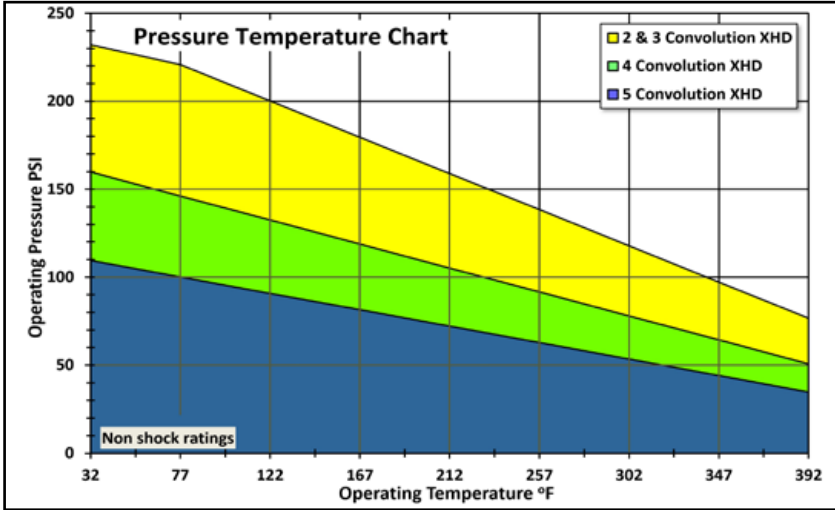

Dimensions and Movements ¹						Weight
Convolutions ⁴	Neutral Length [Inches]	Minimum Length [Inches]	Maximum Length [Inches]	Lateral +/- [Inches]	Angular +/- [degrees]	[lbs]
FFB 2	2.64	2.05	3.23	0.31	7	22
FFB 3	3.58	2.76	4.41	0.47	10	22
FFB 4	4.53	3.46	5.59	0.63	13	22
FFB 5	5.47	4.17	6.77	0.79	17	22

Spring Rates ² @ 68°F +/- 50%			
Axial Compression [lb / 1/8"]	Axial Extension [lb / 1/8"]	Lateral [lb / 1/8"]	Angular [inch-lbs / °]
378	136	222	89
252	91	148	62
189	68	111	44
151	54	89	35

Materials	
Component	Materials
Bellows	Paste Extruded Virgin PTFE to ASTM D4895
Flanges	Carbon Steel to BS1501-161-430A / P265GH Typical
Paint	Ultra-High Temperature in Silver
Root Rings	Stainless Steel to 320S31 (316Ti)
Tie Rods & Nuts	Carbon Steel Grade 8.8 Zinc Plated
Limit Sleeves	Stainless Steel to ASTM A312 Gr. 304/304L

Flanges	
	ASME Class 150
Raised Face Ø	6.19"
Bolt Circle Ø	7.50"
Flange Ø max	12.12"
Bolt Holes ³ [No x Thread]	8 x 5/8" UNC
Thickness	0.62"
Effective Area	15.8" ²

Options	
Component	Options
Bellows	Paste Extruded Static-Dissipating ASTM D4895
Flanges	Stainless Steel, Hastelloy, Low Temperature Steels etc.
Root Rings	Hastelloy, Monel etc.
Tie Rods & Nuts	Stainless Steel, Hastelloy, Monel etc.
Anti-Snake Rings	Stainless Steel

Vacuum Performance PSI (g)				
Model	68°F	212°F	300°F	400°F
FFB 2 XHD	Full vac.	Full vac.	Full vac.	Full vac.
FFB 3 XHD	Full vac.	Full vac.	Full vac.	Full vac.
FFB 4 XHD	Full vac.	Full vac.	Full vac.	Full vac.
FFB 5 XHD	Full vac.	Full vac.	Full vac.	Full vac.

Notes:

- Larger movements are available with more convolutions if required. These are not combined movements please refer to page 7.
- Please refer to page 5 for temperature correction factors for spring rate.
- As standard flange holes are threaded. Clearance holes are possible for certain sizes please contact us.
- The maximum number of convolutions for this size is 10, please consult us for further information on these.
- For operating temperature and pressure for more than 5 convolutions please contact us.

FluoroFlow FFB PTFE Bellows are manufactured from virgin or static dissipating paste extruded HiPerFlon® PTFE. They are manufactured using a unique process which ensures a uniform PTFE wall thickness and eliminates stress in the PTFE from the convolution process. These bellows have an Extra Heavy Duty "XHD" liner.

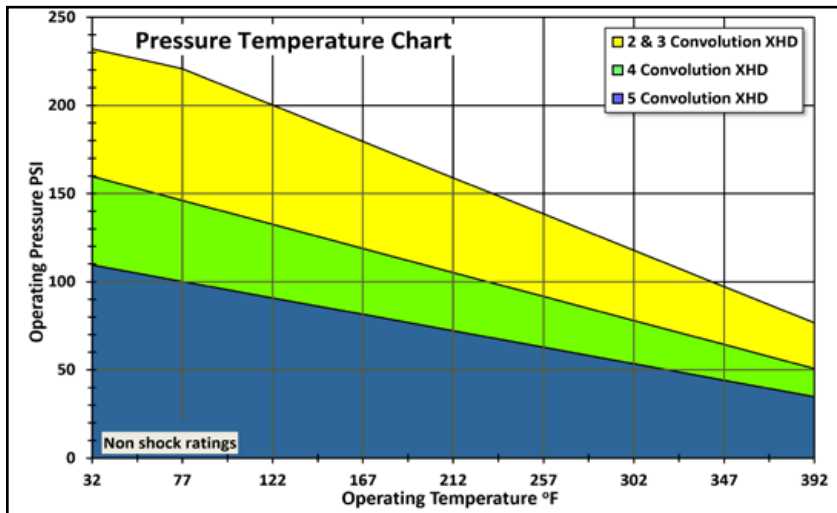

Dimensions and Movements ¹						Weight
Convolutions ⁴	Neutral Length [Inches]	Minimum Length [Inches]	Maximum Length [Inches]	Lateral +/- [Inches]	Angular +/- [degrees]	[lbs]
FFB 2	2.95	2.36	3.54	0.31	6	26
FFB 3	4.06	3.23	4.88	0.47	9	29
FFB 4	5.16	4.06	6.26	0.63	12	29
FFB 5	6.26	4.92	7.60	0.79	15	29

Spring Rates ² @ 68°F +/- 50%			
Axial Compression [lb / 1/8"]	Axial Extension [lb / 1/8"]	Lateral [lb / 1/8"]	Angular [inch-lbs / °]
323	161	254	144
216	107	169	96
162	81	127	72
129	64	101	58

Materials	
Component	Materials
Bellows	Paste Extruded Virgin PTFE to ASTM D4895
Flanges	Carbon Steel to BS1501-161-430A / P265GH Typical
Paint	Ultra-High Temperature in Silver
Root Rings	Stainless Steel to 320S31 (316Ti)
Tie Rods & Nuts	Carbon Steel Grade 8.8 Zinc Plated
Limit Sleeves	Stainless Steel to ASTM A312 Gr. 304/304L

Flanges	
	ASME Class 150
Raised Face Ø	7.31"
Bolt Circle Ø	8.50"
Flange Ø max	13.11"
Bolt Holes ³ [No x Thread]	8 x 3/4"UNC
Thickness	0.78"
Effective Area	26.8" ²

Options	
Component	Options
Bellows	Paste Extruded Static-Dissipating ASTM D4895
Flanges	Stainless Steel, Hastelloy, Low Temperature Steels etc.
Root Rings	Hastelloy, Monel etc.
Tie Rods & Nuts	Stainless Steel, Hastelloy, Monel etc.
Anti-Snake Rings	Stainless Steel

Vacuum Performance PSI (g)				
Model	68°F	212°F	300°F	400°F
FFB 2 XHD	Full vac.	Full vac.	Full vac.	Full vac.
FFB 3 XHD	Full vac.	Full vac.	Full vac.	Full vac.
FFB 4 XHD	Full vac.	Full vac.	Full vac.	Full vac.
FFB 5 XHD	Full vac.	Full vac.	Full vac.	Full vac.

Notes:

- Larger movements are available with more convolutions if required. These are not combined movements please refer to page 7.
- Please refer to page 5 for temperature correction factors for spring rate.
- As standard flange holes are threaded. Clearance holes are possible for certain sizes please contact us.
- The maximum number of convolutions for this size is 10, please consult us for further information on these.
- For operating temperature and pressure for more than 5 convolutions please contact us.

FluoroFlow FFB PTFE Bellows are manufactured from virgin or static dissipating paste extruded HiPerFlon® PTFE. They are manufactured using a unique process which ensures a uniform PTFE wall thickness and eliminates stress in the PTFE from the convolution process. These bellows have an Extra Heavy Duty "XHD" liner.

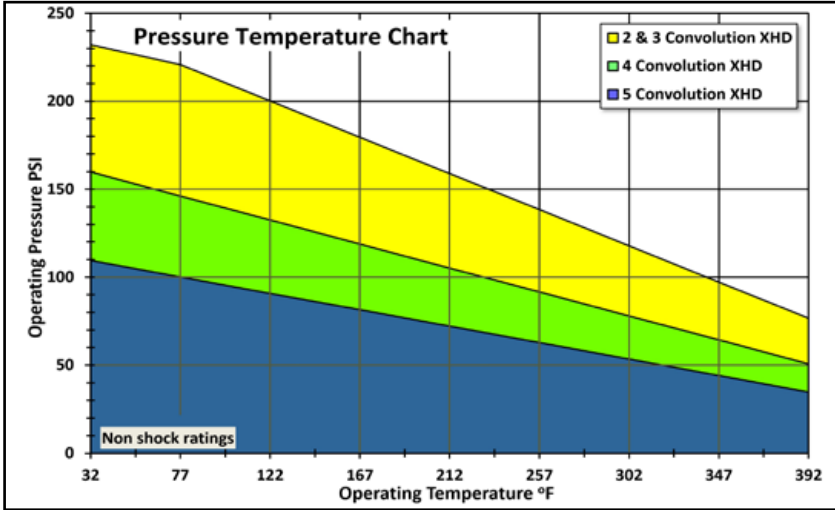

Dimensions and Movements ¹						Weight
Convolutions ⁴	Neutral Length [Inches]	Minimum Length [Inches]	Maximum Length [Inches]	Lateral +/- [Inches]	Angular +/- [degrees]	[lbs]
FFB 2	2.95	2.32	3.58	0.31	6	33
FFB 3	4.06	3.19	4.92	0.47	8	33
FFB 4	5.16	4.02	6.30	0.67	11	35
FFB 5	6.26	4.88	7.64	0.83	14	35

Spring Rates ² @ 68°F +/- 50%			
Axial Compression [lb / 1/8"]	Axial Extension [lb / 1/8"]	Lateral [lb / 1/8"]	Angular [inch-lbs / °]
642	214	428	310
428	143	286	204
321	107	214	150
257	86	171	124

Materials	
Component	Materials
Bellows	Paste Extruded Virgin PTFE to ASTM D4895
Flanges	Carbon Steel to BS1501-161-430A / P265GH Typical
Paint	Ultra-High Temperature in Silver
Root Rings	Stainless Steel to 320S31 (316Ti)
Tie Rods & Nuts	Carbon Steel Grade 8.8 Zinc Plated
Limit Sleeves	Stainless Steel to ASTM A312 Gr. 304/304L

Flanges	
	ASME Class 150
Raised Face Ø	8.5"
Bolt Circle Ø	9.5"
Flange Ø max	14.88"
Bolt Holes ³ [No x Thread]	8 x 3/4" UNC
Thickness	0.78"
Effective Area	32.4" ²

Options	
Component	Options
Bellows	Paste Extruded Static-Dissipating ASTM D4895
Flanges	Stainless Steel, Hastelloy, Low Temperature Steels etc.
Root Rings	Hastelloy, Monel etc.
Tie Rods & Nuts	Stainless Steel, Hastelloy, Monel etc.
Anti-Snake Rings	Stainless Steel

Vacuum Performance PSI (g)				
Model	68°F	212°F	300°F	400°F
FFB 2 XHD	Full vac.	Full vac.	Full vac.	Full vac.
FFB 3 XHD	Full vac.	Full vac.	Full vac.	Full vac.
FFB 4 XHD	Full vac.	Full vac.	Full vac.	Full vac.
FFB 5 XHD	Full vac.	Full vac.	Full vac.	Full vac.

Notes:

1. Larger movements are available with more convolutions if required. These are not combined movements please refer to page 7.
2. Please refer to page 5 for temperature correction factors for spring rate.
3. As standard flange holes are threaded. Clearance holes are possible for certain sizes please contact us.
4. The maximum number of convolutions for this size is 10, please consult us for further information on these.
5. For operating temperature and pressure for more than 5 convolutions please contact us.

FluoroFlow FFB PTFE Bellows are manufactured from virgin or static dissipating paste extruded HiPerFlon® PTFE. They are manufactured using a unique process which ensures a uniform PTFE wall thickness and eliminates stress in the PTFE from the convolution process. These bellows have an Extra Heavy Duty "XHD" liner.

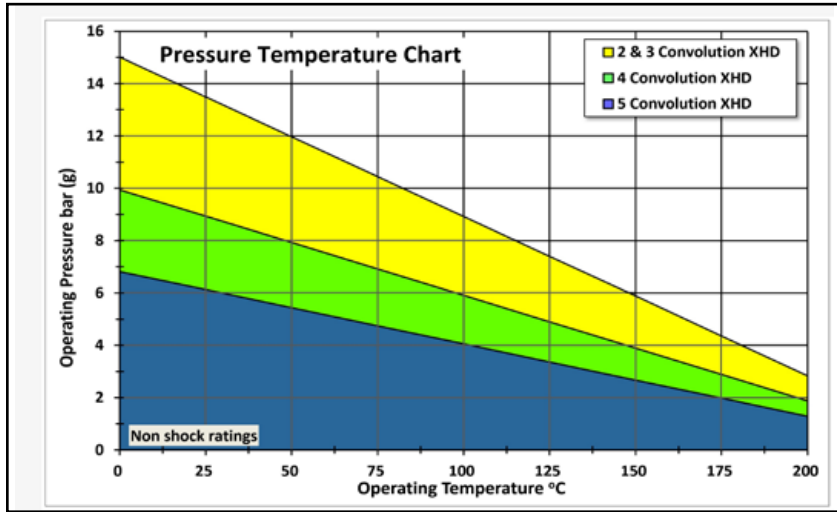

Dimensions and Movements ¹						Weight
Convolutions ⁴	Neutral Length [Inches]	Minimum Length [Inches]	Maximum Length [Inches]	Lateral +/- [Inches]	Angular +/- [degrees]	[lbs]
FFB 2	2.95	2.28	3.62	0.31	5	44
FFB 3	4.06	3.11	5.00	0.47	8	44
FFB 4	5.16	3.94	6.38	0.67	10	46
FFB 5	6.26	4.76	7.76	0.83	12	46

Spring Rates ² @ 68°F +/- 50%			
Axial Compression [lb / 1/8"]	Axial Extension [lb / 1/8"]	Lateral [lb / 1/8"]	Angular [inch-lbs / °]
777	257	482	628
518	171	321	419
389	128	241	314
311	103	193	251

Materials	
Component	Materials
Bellows	Paste Extruded Virgin PTFE to ASTM D4895
Flanges	Carbon Steel to BS1501-161-430A / P265GH Typical
Paint	Ultra-High Temperature in Silver
Root Rings	Stainless Steel to 320S31 (316Ti)
Tie Rods & Nuts	Carbon Steel Grade 8.8 Zinc Plated
Limit Sleeves	Stainless Steel to ASTM A312 Gr. 304/304L

Flanges	
	ASME Class 150
Raised Face Ø	10.62"
Bolt Circle Ø	11.75"
Flange Ø max	17.32"
Bolt Holes ³ [No x Thread]	8 x 3/4" UNC
Thickness	0.78"
Effective Area	54.7" ²

Options	
Component	Options
Bellows	Paste Extruded Static-Dissipating ASTM D4895
Flanges	Stainless Steel, Hastelloy, Low Temperature Steels etc.
Root Rings	Hastelloy, Monel etc.
Tie Rods & Nuts	Stainless Steel, Hastelloy, Monel etc.
Anti-Snake Rings	Stainless Steel

Vacuum Performance PSI (g)				
Model	68°F	212°F	300°F	400°F
FFB 2 XHD	Full vac.	Full vac.	Full vac.	Full vac.
FFB 3 XHD	Full vac.	Full vac.	Full vac.	Full vac.
FFB 4 XHD	Full vac.	Full vac.	Full vac.	-11.6
FFB 5 XHD	Full vac.	Full vac.	Full vac.	-11.6

- Notes:
- Larger movements are available with more convolutions if required. These are not combined movements please refer to page 7.
 - Please refer to page 5 for temperature correction factors for spring rate.
 - As standard flange holes are threaded. Clearance holes are possible for certain sizes please contact us.
 - The maximum number of convolutions for this size is 10, please consult us for further information on these.
 - For operating temperature and pressure for more than 5 convolutions please contact us.

FluoroFlow FFB PTFE Bellows are manufactured from virgin or static dissipating paste extruded HiPerFlon® PTFE. They are manufactured using a unique process which ensures a uniform PTFE wall thickness and eliminates stress in the PTFE from the convolution process. These bellows have an Extra Heavy Duty "XHD" liner.

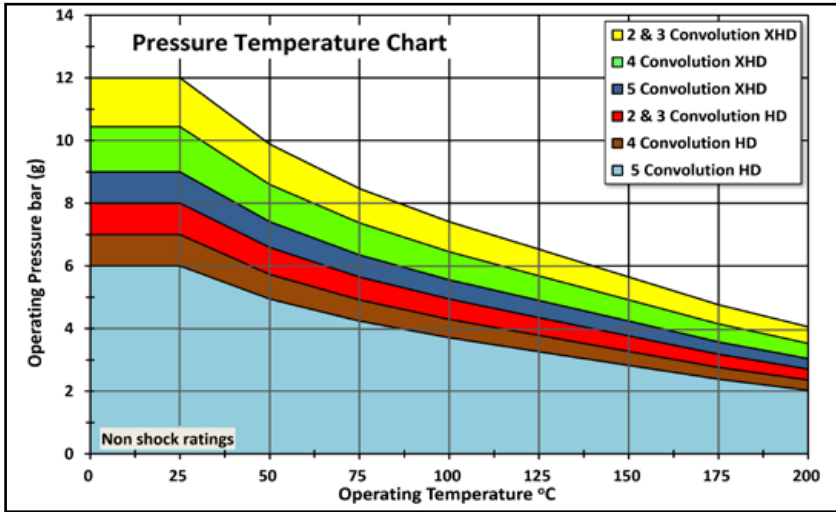

Dimensions and Movements ¹						Weight
Convolutions ⁴	Neutral Length [Inches]	Minimum Length [Inches]	Maximum Length [Inches]	Lateral +/- [Inches]	Angular +/- [degrees]	[lbs]
FFB 2	3.07	2.32	3.82	0.31	5	55
FFB 3	4.21	3.19	5.24	0.47	7	57
FFB 4	5.31	4.06	6.57	0.67	9	57
FFB 5	6.46	4.92	7.99	0.83	11	59

Spring Rates ² @ 68°F +/- 50%			
Axial Compression [lb / 1/8"]	Axial Extension [lb / 1/8"]	Lateral [lb / 1/8"]	Angular [inch-lbs / °]
1606	402	348	1956
1071	268	232	1301
803	201	174	974
642	161	139	779

Materials	
Component	Materials
Bellows	Paste Extruded Virgin PTFE to ASTM D4895
Flanges	Carbon Steel to BS1501-161-430A / P265GH Typical
Paint	Ultra-High Temperature in Silver
Root Rings	Stainless Steel to 320S31 (316Ti)
Tie Rods & Nuts	Carbon Steel Grade 8.8 Zinc Plated
Limit Sleeves	Stainless Steel to ASTM A312 Gr. 304/304L

Flanges	
	ASME Class 150
Raised Face Ø	12.75"
Bolt Circle Ø	14.25"
Flange Ø max	20.23"
Bolt Holes ³ [No x Thread]	12 x 7/8" UNC
Thickness	0.78"
Effective Area	87.7" ²

Options	
Component	Options
Bellows	Paste Extruded Static-Dissipating ASTM D4895
Flanges	Stainless Steel, Hastelloy, Low Temperature Steels etc.
Root Rings	Hastelloy, Monel etc.
Tie Rods & Nuts	Stainless Steel, Hastelloy, Monel etc.
Anti-Snake Rings	Stainless Steel

Vacuum Performance PSI (g)				
Model	68°F	212°F	300°F	400°F
FFB 2 XHD	Full vac.	Full vac.	Full vac.	-13.0
FFB 3 XHD	Full vac.	Full vac.	-13.0	-11.6
FFB 4 XHD	Full vac.	-11.6	-10.1	-8.7
FFB 5 XHD	Full vac.	-10.1	-8.7	-8.7

Notes:

1. Larger movements are available with more convolutions if required. These are not combined movements please refer to page 7.
2. Please refer to page 5 for temperature correction factors for spring rate.
3. As standard flange holes are threaded. Clearance holes are possible for certain sizes please contact us.
4. The maximum number of convolutions for this size is 10, please consult us for further information on these.
5. For operating temperature and pressure for more than 5 convolutions please contact us.

FluoroFlow FFB PTFE Bellows are manufactured from virgin or static dissipating paste extruded HiPerFlon® PTFE. They are manufactured using a unique process which ensures a uniform PTFE wall thickness and eliminates stress in the PTFE from the convolution process. These bellows are available with Heavy Duty “HD” or Extra Heavy Duty “XHD” liner.

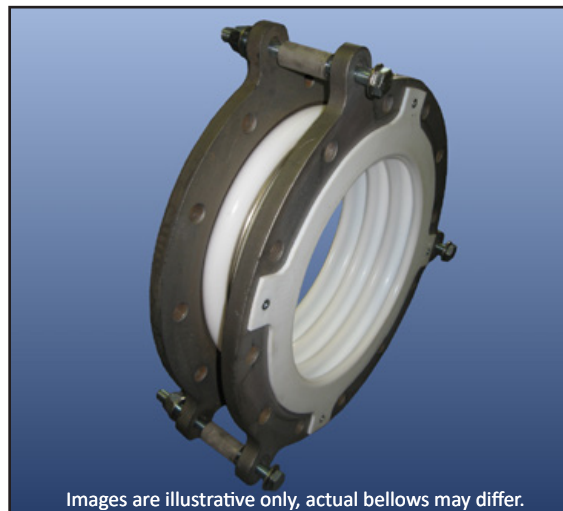
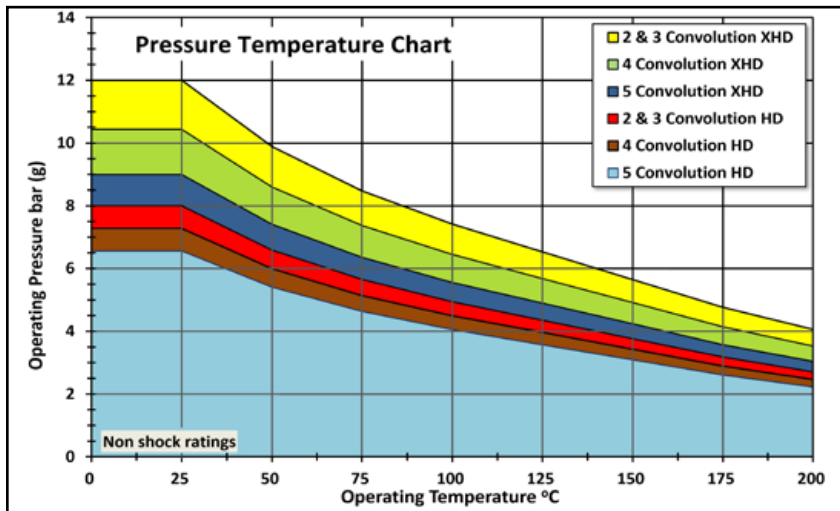

Dimensions and Movements ¹						Weight
Convolutions ⁴	Neutral Length [Inches]	Minimum Length [Inches]	Maximum Length [Inches]	Lateral +/- [Inches]	Angular +/- [degrees]	[lbs]
FFB 2	3.74	2.99	4.49	0.35	4	79
FFB 3	5.20	4.17	6.22	0.51	6	79
FFB 4	6.65	5.35	7.95	0.71	8	81
FFB 5	8.11	6.54	9.69	0.87	9	81

Spring Rates ² @ 68°F +/- 50%			
Axial Compression [lb / 1/8"]	Axial Extension [lb / 1/8"]	Lateral [lb / 1/8"]	Angular [inch-lbs / °]
1481	493	454	2638
987	328	303	1761
740	246	227	1319
592	197	181	1053

Materials	
Component	Materials
Bellows	Multi-ply Virgin PTFE to ASTM D4894 Type IV
Flanges	Carbon Steel to BS1501-161-430A / P265GH Typical
Paint	Ultra-High Temperature in Silver
Root Rings	Stainless Steel to 320S31 (316Ti)
Tie Rods & Nuts	Carbon Steel Grade 8.8 Zinc Plated
Limit Sleeves	Stainless Steel to ASTM A312 Gr. 304/304L

Flanges	
	ASME Class 150
Raised Face Ø	15.00"
Bolt Circle Ø	17"
Flange Ø max	23.22"
Bolt Holes ³ [No x Thread]	12 x 7/8" UNC
Thickness	0.78"
Effective Area	120.4" ²

Options	
Component	Options
Bellows	Paste Extruded Static-Dissipating ASTM D4895
Flanges	Stainless Steel, Hastelloy, Low Temperature Steels etc.
Root Rings	Hastelloy, Monel etc.
Tie Rods & Nuts	Stainless Steel, Hastelloy, Monel etc.
Anti-Snake Rings	Stainless Steel

Vacuum Performance PSI (g)			
Model	68°F	212°F	300°F
FFB 2 HD	Full vac.	Full vac.	-0.0
FFB 3 HD	Full vac.	Full vac.	-0.0
FFB 2 XHD	Full vac.	Full vac.	Full vac.
FFB 3 XHD	Full vac.	Full vac.	-13.0

Notes:

- Larger movements are available with more convolutions if required. These are not combined movements please refer to page 7.
- Please refer to page 5 for temperature correction factors for spring rate.
- As standard flange holes are threaded. Clearance holes are possible for certain sizes please contact us.
- The maximum number of convolutions for this size is 10, please consult us for further information on these.
- For operating temperature and pressure for more than 5 convolutions please contact us.

FluoroFlow FFB PTFE Bellows are manufactured from virgin or static dissipating paste extruded HiPerFlon® PTFE. They are manufactured using a unique process which ensures a uniform PTFE wall thickness and eliminates stress in the PTFE from the convolution process. These bellows are available with Heavy Duty "HD" or Extra Heavy Duty "XHD" liner.

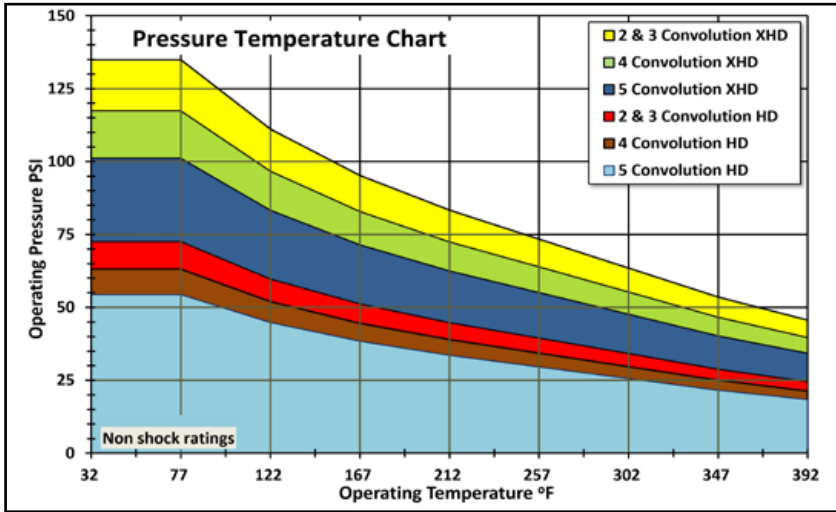

Dimensions and Movements ¹						Weight
Convolutions ⁴	Neutral Length [Inches]	Minimum Length [Inches]	Maximum Length [Inches]	Lateral +/- [Inches]	Angular +/- [degrees]	[lbs]
FFB 2	3.86	3.07	4.65	0.31	3	143
FFB 3	5.39	4.33	6.46	0.47	5	145
FFB 4	6.93	5.59	8.27	0.67	6	147
FFB 5	8.46	6.85	10.08	0.83	7	150

Spring Rates ² @ 68°F +/- 50%			
Axial Compression [lb / 1/8"]	Axial Extension [lb / 1/8"]	Lateral [lb / 1/8"]	Angular [inch-lbs / °]
1109	728	719	3399
739	485	480	2266
555	364	360	1699
444	291	288	1354

Materials	
Component	Materials
Bellows	Multi-ply Virgin PTFE to ASTM D4894 Type IV
Flanges	Carbon Steel to BS1501-161-430A / P265GH Typical
Paint	Ultra-High Temperature in Silver
Root Rings	Stainless Steel to 320S31 (316Ti)
Tie Rods & Nuts	Carbon Steel Grade 8.8 Zinc Plated
Limit Sleeves	Stainless Steel to ASTM A312 Gr. 304/304L

Flanges	
	ASME Class 150
Raised Face Ø	16.25"
Bolt Circle Ø	18.75"
Flange Ø max	25.19"
Bolt Holes ³ [No x Thread]	12 x 1" UNC
Thickness	0.86"
Effective Area	166.5" ²

Options	
Component	Options
Bellows	Paste Extruded Static-Dissipating ASTM D4895
Flanges	Stainless Steel, Hastelloy, Low Temperature Steels etc.
Root Rings	Hastelloy, Monel etc.
Tie Rods & Nuts	Stainless Steel, Hastelloy, Monel etc.
Anti-Snake Rings	Stainless Steel

Vacuum Performance	
Whilst the standard bellows are not suitable for use under vacuum, they can be supplied with internal vacuum support rings to provide full vacuum performance. Vacuum support rings can be manufactured from Hastelloy, Titanium, Tantalum or PTFE encapsulated etc.	

Notes:

- Larger movements are available with more convolutions if required. These are not combined movements please refer to page 7.
- Please refer to page 5 for temperature correction factors for spring rate.
- As standard flange holes are threaded. Clearance holes are possible for certain sizes please contact us.
- The maximum number of convolutions for this size is 10, please consult us for further information on these.
- For operating temperature and pressure for more than 5 convolutions please contact us.

FluoroFlow FFB PTFE Bellows are manufactured from virgin or static dissipating paste extruded HiPerFlon® PTFE. They are manufactured using a unique process which ensures a uniform PTFE wall thickness and eliminates stress in the PTFE from the convolution process. These bellows are available with Heavy Duty “HD” or Extra Heavy Duty “XHD” liner.

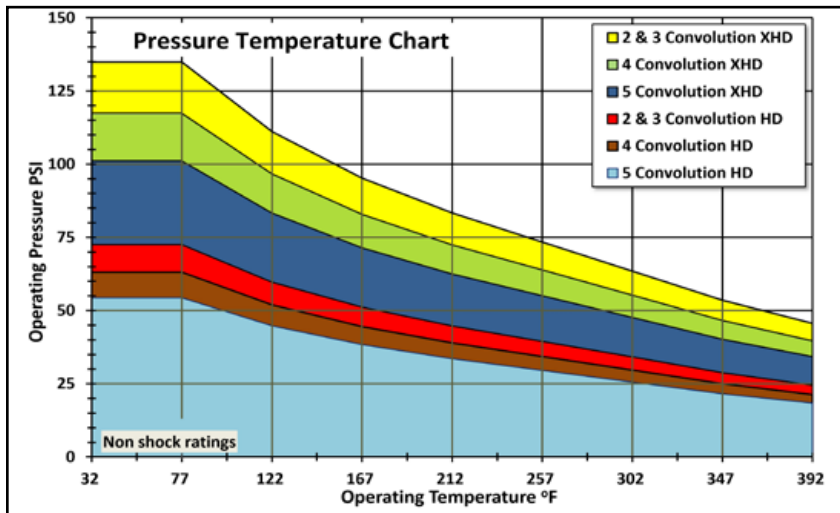

Dimensions and Movements ¹						Weight
Convolutions ⁴	Neutral Length [Inches]	Minimum Length [Inches]	Maximum Length [Inches]	Lateral +/- [Inches]	Angular +/- [degrees]	[lbs]
FFB 2	4.61	3.82	5.39	0.39	3	174
FFB 3	6.38	5.28	7.48	0.59	4	176
FFB 4	8.15	6.73	9.57	0.79	6	178
FFB 5	9.92	8.19	11.65	0.98	7	183

Spring Rates ² @ 68°F +/- 50%			
Axial Compression [lb / 1/8"]	Axial Extension [lb / 1/8"]	Lateral [lb / 1/8"]	Angular [inch-lbs / °]
1039	621	985	504
692	414	657	336
520	310	493	257
415	248	394	204

Materials	
Component	Materials
Bellows	Multi-ply Virgin PTFE to ASTM D4894 Type IV
Flanges	Carbon Steel to BS1501-161-430A / P265GH Typical
Paint	Ultra-High Temperature in Silver
Root Rings	Stainless Steel to 320S31 (316Ti)
Tie Rods & Nuts	Carbon Steel Grade 8.8 Zinc Plated
Limit Sleeves	Stainless Steel to ASTM A312 Gr. 304/304L

Flanges	
	ASME Class 150
Raised Face Ø	18.50"
Bolt Circle Ø	21.25"
Flange Ø max	27.55"
Bolt Holes ³ [No x Thread]	16 x 1" UNC
Thickness	0.78"
Effective Area	218.7" ²

Options	
Component	Options
Bellows	Paste Extruded Static-Dissipating ASTM D4895
Flanges	Stainless Steel, Hastelloy, Low Temperature Steels etc.
Root Rings	Hastelloy, Monel etc.
Tie Rods & Nuts	Stainless Steel, Hastelloy, Monel etc.
Anti-Snake Rings	Stainless Steel

Vacuum Performance

Whilst the standard bellows are not suitable for use under vacuum, they can be supplied with internal vacuum support rings to provide full vacuum performance. Vacuum support rings can be manufactured from Hastelloy, Titanium, Tantalum or PTFE encapsulated etc.

- Notes:
- Larger movements are available with more convolutions if required. These are not combined movements please refer to page 7.
 - Please refer to page 5 for temperature correction factors for spring rate.
 - As standard flange holes are threaded. Clearance holes are possible for certain sizes please contact us.
 - The maximum number of convolutions for this size is 10, please consult us for further information on these.
 - For operating temperature and pressure for more than 5 convolutions please contact us.

FluoroFlow FFB PTFE Bellows are manufactured from virgin or static dissipating paste extruded HiPerFlon® PTFE. They are manufactured using a unique process which ensures a uniform PTFE wall thickness and eliminates stress in the PTFE from the convolution process. These bellows are available with Heavy Duty “HD” or Extra Heavy Duty “XHD” liner.

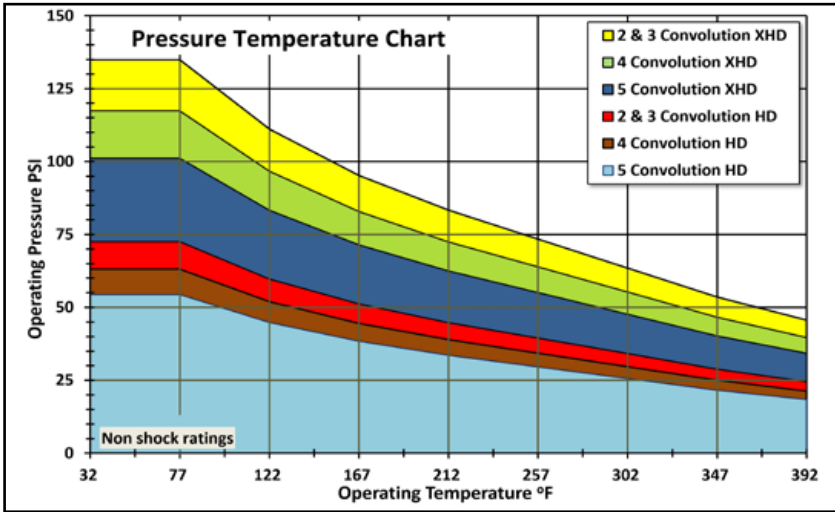

Dimensions and Movements ¹						Weight
Convolutions ⁴	Neutral Length [Inches]	Minimum Length [Inches]	Maximum Length [Inches]	Lateral +/- [Inches]	Angular +/- [degrees]	[lbs]
FFB 2	4.65	3.86	5.43	0.43	3	180
FFB 3	6.42	5.31	7.52	0.59	4	185
FFB 4	8.19	6.77	9.61	0.79	5	187
FFB 5	9.96	8.23	11.69	0.94	7	189

Spring Rates ² @ 68°F +/- 50%			
Axial Compression [lb / 1/8"]	Axial Extension [lb / 1/8"]	Lateral [lb / 1/8"]	Angular [inch-lbs / °]
1660	921	1108	584
1106	614	739	389
830	460	554	292
664	368	443	230

Materials	
Component	Materials
Bellows	Multi-ply Virgin PTFE to ASTM D4894 Type IV
Flanges	Carbon Steel to BS1501-161-430A / P265GH Typical
Paint	Ultra-High Temperature in Silver
Root Rings	Stainless Steel to 320S31 (316Ti)
Tie Rods & Nuts	Carbon Steel Grade 8.8 Zinc Plated
Limit Sleeves	Stainless Steel to ASTM A312 Gr. 304/304L

Flanges	
	ASME Class 150
Raised Face Ø	21.00"
Bolt Circle Ø	22.75"
Flange Ø max	29.13"
Bolt Holes ³ [No x Thread]	16 x 1.1/8" UNC
Thickness	0.86"
Effective Area	279.0" ²

Options	
Component	Options
Bellows	Paste Extruded Static-Dissipating ASTM D4895
Flanges	Stainless Steel, Hastelloy, Low Temperature Steels etc.
Root Rings	Hastelloy, Monel etc.
Tie Rods & Nuts	Stainless Steel, Hastelloy, Monel etc.
Anti-Snake Rings	Stainless Steel

Vacuum Performance

Whilst the standard bellows are not suitable for use under vacuum, they can be supplied with internal vacuum support rings to provide full vacuum performance. Vacuum support rings can be manufactured from Hastelloy, Titanium, Tantalum or PTFE encapsulated etc.

Notes:

1. Larger movements are available with more convolutions if required. These are not combined movements please refer to page 7.
2. Please refer to page 5 for temperature correction factors for spring rate.
3. As standard flange holes are threaded. Clearance holes are possible for certain sizes please contact us.
4. The maximum number of convolutions for this size is 10, please consult us for further information on these.
5. For operating temperature and pressure for more than 5 convolutions please contact us.

FluoroFlow FFB PTFE Bellows are manufactured from virgin or static dissipating paste extruded HiPerFlon® PTFE. They are manufactured using a unique process which ensures a uniform PTFE wall thickness and eliminates stress in the PTFE from the convolution process. These bellows are available with Heavy Duty “HD” or Extra Heavy Duty “XHD” liner.

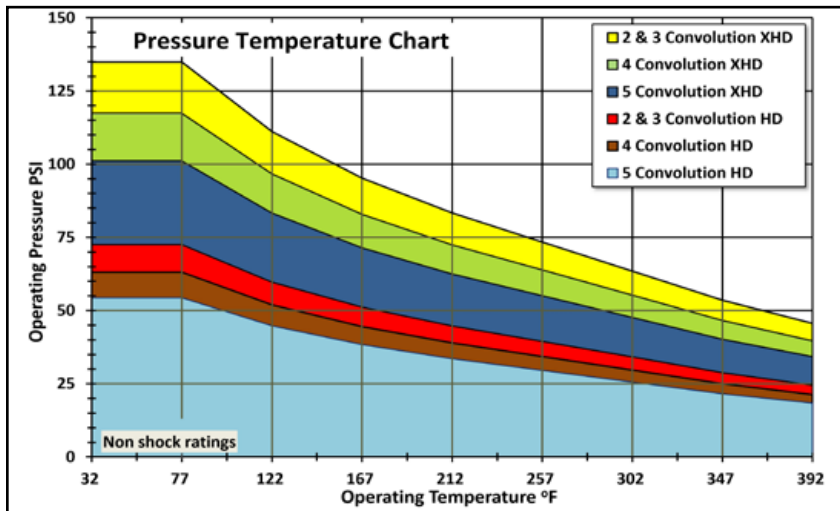

Dimensions and Movements ¹						Weight
Convolutions ⁴	Neutral Length [Inches]	Minimum Length [Inches]	Maximum Length [Inches]	Lateral +/- [Inches]	Angular +/- [degrees]	[lbs]
FFB 2	4.92	4.13	5.71	0.43	2	229
FFB 3	6.69	5.59	7.80	0.59	4	233
FFB 4	8.46	7.05	9.88	0.79	5	237
FFB 5	10.24	8.50	11.97	0.94	6	240

Spring Rates ² @ 68°F +/- 50%			
Axial Compression [lb / 1/8"]	Axial Extension [lb / 1/8"]	Lateral [lb / 1/8"]	Angular [inch-lbs / °]
2045	1146	1231	655
1363	764	821	443
1023	573	616	327
818	458	493	266

Materials	
Component	Materials
Bellows	Multi-ply Virgin PTFE to ASTM D4894 Type IV
Flanges	Carbon Steel to BS1501-161-430A / P265GH Typical
Paint	Ultra-High Temperature in Silver
Root Rings	Stainless Steel to 320S31 (316Ti)
Tie Rods & Nuts	Carbon Steel Grade 8.8 Zinc Plated
Limit Sleeves	Stainless Steel to ASTM A312 Gr. 304/304L

Flanges	
	ASME Class 150
Raised Face Ø	23.00"
Bolt Circle Ø	25.00"
Flange Ø max	32.67"
Bolt Holes ³ [No x Thread]	20 x 1.1/8" UNC
Thickness	1.0"
Effective Area	335.4" ²

Options	
Component	Options
Bellows	Paste Extruded Static-Dissipating ASTM D4895
Flanges	Stainless Steel, Hastelloy, Low Temperature Steels etc.
Root Rings	Hastelloy, Monel etc.
Tie Rods & Nuts	Stainless Steel, Hastelloy, Monel etc.
Anti-Snake Rings	Stainless Steel

Vacuum Performance

Whilst the standard bellows are not suitable for use under vacuum, they can be supplied with internal vacuum support rings to provide full vacuum performance. Vacuum support rings can be manufactured from Hastelloy, Titanium, Tantalum or PTFE encapsulated etc.

- Notes:
- Larger movements are available with more convolutions if required. These are not combined movements please refer to page 7.
 - Please refer to page 5 for temperature correction factors for spring rate.
 - As standard flange holes are threaded. Clearance holes are possible for certain sizes please contact us.
 - The maximum number of convolutions for this size is 10, please consult us for further information on these.
 - For operating temperature and pressure for more than 5 convolutions please contact us.

FluoroFlow FFB PTFE Bellows are manufactured from virgin or static dissipating paste extruded HiPerFlon® PTFE. They are manufactured using a unique process which ensures a uniform PTFE wall thickness and eliminates stress in the PTFE from the convolution process. These bellows are available with Heavy Duty "HD" or Extra Heavy Duty "XHD" liner.

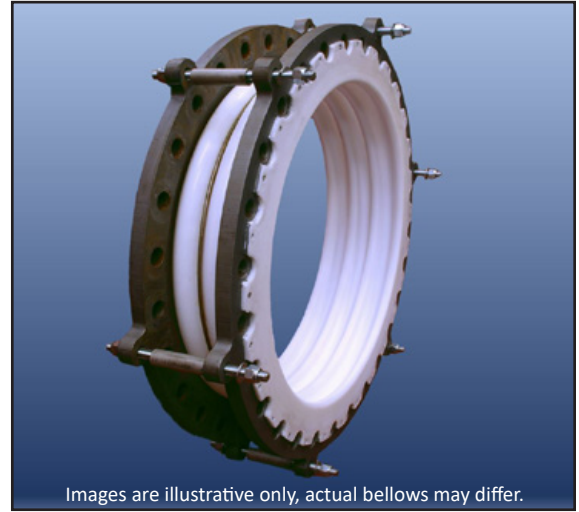
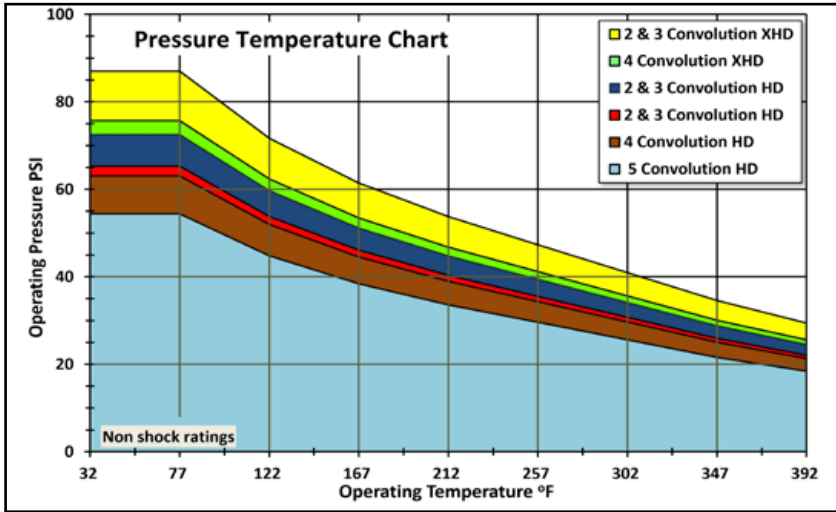

Dimensions and Movements ¹						Weight
Convolutions ⁴	Neutral Length [Inches]	Minimum Length [Inches]	Maximum Length [Inches]	Lateral +/- [Inches]	Angular +/- [degrees]	[lbs]
FFB 2	5.12	4.33	5.91	0.43	2	308
FFB 3	6.89	5.79	7.99	0.59	3	312
FFB 4	8.66	7.20	10.12	0.79	4	319
FFB 5	10.43	8.66	12.20	0.94	5	323

Spring Rates ² @ 68°F +/- 50%			
Axial Compression [lb / 1/8"]	Axial Extension [lb / 1/8"]	Lateral [lb / 1/8"]	Angular [inch-lbs / °]
2136	1435	2666	655
1424	956	1777	443
1069	718	1333	327
854	574	1066	266

Materials	
Component	Materials
Bellows	Multi-ply Virgin PTFE to ASTM D4894 Type IV
Flanges	Carbon Steel to BS1501-161-430A / P265GH Typical
Paint	Ultra-High Temperature in Silver
Root Rings	Stainless Steel to 320S31 (316Ti)
Tie Rods & Nuts	Carbon Steel Grade 8.8 Zinc Plated
Limit Sleeves	Stainless Steel to ASTM A312 Gr. 304/304L

Flanges	
	ASME Class 150
Raised Face Ø	27.25"
Bolt Circle Ø	29.50"
Flange Ø max	36.81"
Bolt Holes ³ [No x Thread]	20 x 1.1/4" UNC
Thickness	1.0"
Effective Area	476.9" ²

Options	
Bellows	Paste Extruded Static-Dissipating ASTM D4895
Flanges	Stainless Steel, Hastelloy, Low Temperature Steels etc.
Root Rings	Hastelloy, Monel etc.
Tie Rods & Nuts	Stainless Steel, Hastelloy, Monel etc.
Anti-Snake Rings	Stainless Steel

Vacuum Performance
Whilst the standard bellows are not suitable for use under vacuum, they can be supplied with internal vacuum support rings to provide full vacuum performance. Vacuum support rings can be manufactured from Hastelloy, Titanium, Tantalum or PTFE encapsulated etc.

Notes:

1. Larger movements are available with more convolutions if required. These are not combined movements please refer to page 7.
2. Please refer to page 5 for temperature correction factors for spring rate.
3. As standard flange holes are threaded. Clearance holes are possible for certain sizes please contact us.
4. The maximum number of convolutions for this size is 6, please consult us for further information on these.
5. For operating temperature and pressure for more than 5 convolutions please contact us.

FluoroFlow FFB PTFE Bellows are manufactured from virgin or static dissipating paste extruded HiPerFlon® PTFE. They are manufactured using a unique process which ensures a uniform PTFE wall thickness and eliminates stress in the PTFE from the convolution process. These bellows are available with Heavy Duty “HD” or Extra Heavy Duty “XHD” liner.

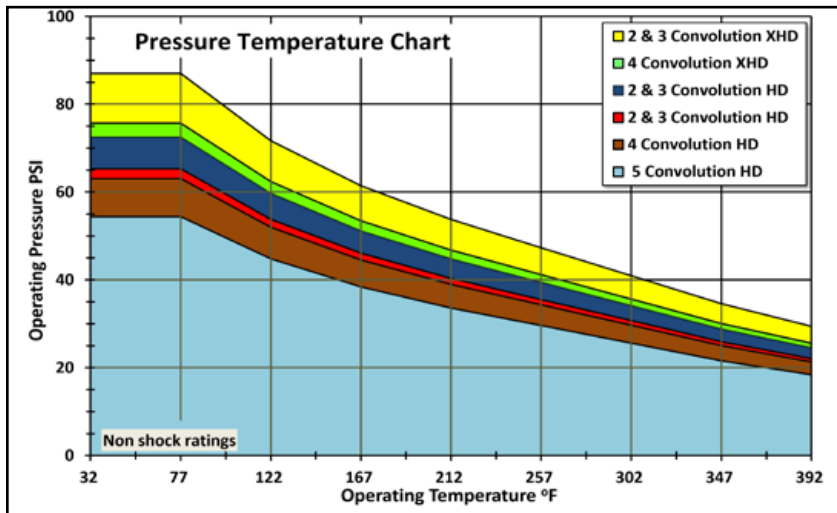

Dimensions and Movements ¹						Weight
Convolutions ⁴	Neutral Length [Inches]	Minimum Length [Inches]	Maximum Length [Inches]	Lateral +/- [Inches]	Angular +/- [degrees]	[lbs]
FFB 2	5.75	4.76	6.73	0.47	2	339
FFB 3	8.15	6.89	9.41	0.63	3	345
FFB 4	10.55	9.02	12.09	0.79	3	352
FFB 5	12.95	11.14	14.76	0.94	4	359

Spring Rates ² @ 68°F +/- 50%			
Axial Compression [lb / 1/8"]	Axial Extension [lb / 1/8"]	Lateral [lb / 1/8"]	Angular [inch-lbs / °]
2227	1724	4101	1195
1485	1149	2734	797
1114	862	2051	593
891	690	1640	478

Materials	
Component	Materials
Bellows	Multi-ply Virgin PTFE to ASTM D4894 Type IV
Flanges	Carbon Steel to BS1501-161-430A / P265GH Typical
Paint	Ultra-High Temperature in Silver
Root Rings	Stainless Steel to 320S31 (316Ti)
Tie Rods & Nuts	Carbon Steel Grade 8.8 Zinc Plated
Limit Sleeves	Stainless Steel to ASTM A312 Gr. 304/304L

Flanges		
	ASME Class 150 Series A	ASME Class 150 Series B
Raised Face Ø	31.50"	30.00"
Bolt Circle Ø	34.00"	31.31"
Flange Ø max	41.75"	38.18"
Bolt Holes ³ [No x Thread]	28 x 1.1/4" UNC	40 x 3/4" UNC
Thickness	1.06"	
Effective Area	655.3" ²	

Options	
Bellows	Paste Extruded Static-Dissipating ASTM D4895
Flanges	Stainless Steel, Hastelloy, Low Temperature Steels etc.
Root Rings	Hastelloy, Monel etc.
Tie Rods & Nuts	Stainless Steel, Hastelloy, Monel etc.
Anti-Snake Rings	Stainless Steel

Vacuum Performance

Whilst the standard bellows are not suitable for use under vacuum, they can be supplied with internal vacuum support rings to provide full vacuum performance. Vacuum support rings can be manufactured from Hastelloy, Titanium, Tantalum or PTFE encapsulated etc.

- Notes:
- Larger movements are available with more convolutions if required. These are not combined movements please refer to page 7.
 - Please refer to page 5 for temperature correction factors for spring rate.
 - As standard flange holes are threaded. Clearance holes are possible for certain sizes please contact us.
 - The maximum number of convolutions for this size is 6, please consult us for further information on these.
 - For operating temperature and pressure for more than 5 convolutions please contact us.

FluoroFlow FFB PTFE Bellows are manufactured from virgin or static dissipating paste extruded HiPerFlon® PTFE. They are manufactured using a unique process which ensures a uniform PTFE wall thickness and eliminates stress in the PTFE from the convolution process. These bellows are available with Heavy Duty "HD" or Extra Heavy Duty "XHD" liner.

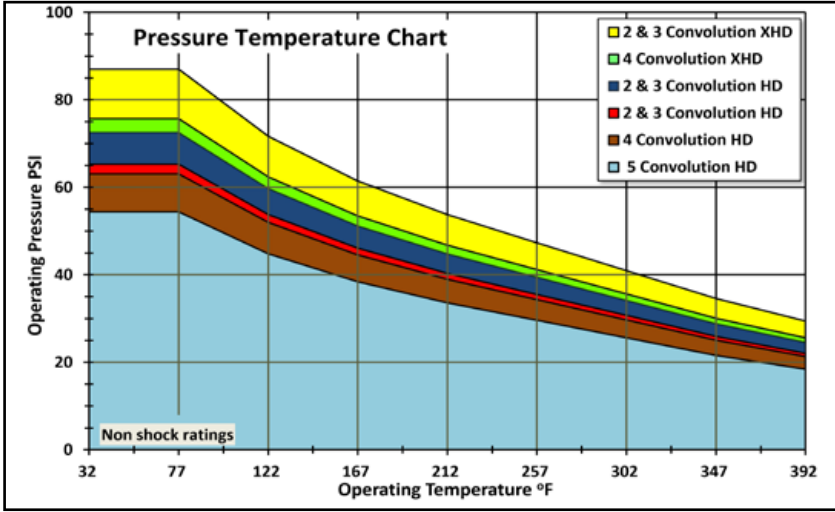

Dimensions and Movements ¹						Weight
Convolutions ⁴	Neutral Length [Inches]	Minimum Length [Inches]	Maximum Length [Inches]	Lateral +/- [Inches]	Angular +/- [degrees]	[lbs]
FFB 2	6.3	5.31	72.8	0.43	2	392
FFB 3	8.7	7.44	9.88	0.59	3	398
FFB 4	11.1	9.57	12.64	0.75	3	405
FFB 5	13.5	11.69	15.31	0.91	4	411

Spring Rates ² @ 68°F +/- 50%			
Axial Compression [lb / 1/8"]	Axial Extension [lb / 1/8"]	Lateral [lb / 1/8"]	Angular [inch-lbs / °]
2384	1849	4386	1283
1588	1231	2926	885
1192	924	2196	646
954	739	1756	513

Materials	
Component	Materials
Bellows	Multi-ply Virgin PTFE to ASTM D4894 Type IV
Flanges	Carbon Steel to BS1501-161-430A / P265GH Typical
Paint	Ultra-High Temperature in Silver
Root Rings	Stainless Steel to 320S31 (316Ti)
Tie Rods & Nuts	Carbon Steel Grade 8.8 Zinc Plated
Limit Sleeves	Stainless Steel to ASTM A312 Gr. 304/304L

Flanges		
	ASME Class 150 Series A	ASME Class 150 Series B
Raised Face Ø	33.75"	32.00"
Bolt Circle Ø	36.00"	33.31"
Flange Ø max	44.00"	40.15"
Bolt Holes ³ [No x Thread]	28 x 1.1/4" UNC	44 x 3/4" UNC
Thickness	1.06"	
Effective Area	731.1" ²	

Options	
Bellows	Paste Extruded Static-Dissipating ASTM D4895
Flanges	Stainless Steel, Hastelloy, Low Temperature Steels etc.
Root Rings	Hastelloy, Monel etc.
Tie Rods & Nuts	Stainless Steel, Hastelloy, Monel etc.
Anti-Snake Rings	Stainless Steel

Vacuum Performance

Whilst the standard bellows are not suitable for use under vacuum, they can be supplied with internal vacuum support rings to provide full vacuum performance. Vacuum support rings can be manufactured from Hastelloy, Titanium, Tantalum or PTFE encapsulated etc.

Notes:

1. Larger movements are available with more convolutions if required. These are not combined movements please refer to page 7.
2. Please refer to page 5 for temperature correction factors for spring rate.
3. As standard flange holes are threaded. Clearance holes are possible for certain sizes please contact us.
4. The maximum number of convolutions for this size is 6, please consult us for further information on these.
5. For operating temperature and pressure for more than 5 convolutions please contact us.

FluoroFlow FFB PTFE Bellows are manufactured from virgin or static dissipating paste extruded HiPerFlon® PTFE. They are manufactured using a unique process which ensures a uniform PTFE wall thickness and eliminates stress in the PTFE from the convolution process. These bellows are available with Heavy Duty "HD" or Extra Heavy Duty "XHD" liner.

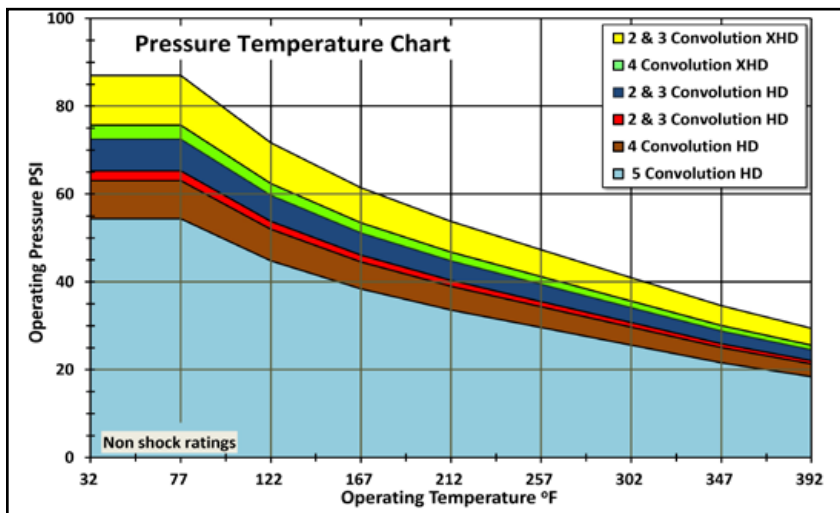

Dimensions and Movements ¹						Weight
Convolutions ⁴	Neutral Length [Inches]	Minimum Length [Inches]	Maximum Length [Inches]	Lateral +/- [Inches]	Angular +/- [degrees]	[lbs]
FFB 2	6.3	5.31	7.28	0.43	2	444
FFB 3	8.7	7.44	9.88	0.59	3	453
FFB 4	11.1	9.57	12.64	0.75	3	462
FFB 5	13.5	11.69	15.31	0.91	4	471

Spring Rates ² @ 68°F +/- 50%			
Axial Compression [lb / 1/8"]	Axial Extension [lb / 1/8"]	Lateral [lb / 1/8"]	Angular [inch-lbs / °]
2541	1963	4675	1354
1694	1308	3117	903
1271	981	2338	682
1016	78	1870	540

Materials	
Component	Materials
Bellows	Multi-ply Virgin PTFE to ASTM D4894 Type IV
Flanges	Carbon Steel to BS1501-161-430A / P265GH Typical
Paint	Ultra-High Temperature in Silver
Root Rings	Stainless Steel to 320S31 (316Ti)
Tie Rods & Nuts	Carbon Steel Grade 8.8 Zinc Plated
Limit Sleeves	Stainless Steel to ASTM A312 Gr. 304/304L

Flanges		
	ASME Class 150 Series A	ASME Class 150 Series B
Raised Face Ø	36.00"	34.00"
Bolt Circle Ø	38.5"	35.44"
Flange Ø max	46.00"	42.12"
Bolt Holes ³ [No x Thread]	28 x 1.1/2" UNC	48 x 3/4" UNC
Thickness	1.18"	
Effective Area	853.9"²	

Options	
Bellows	Paste Extruded Static-Dissipating ASTM D4895
Flanges	Stainless Steel, Hastelloy, Low Temperature Steels etc.
Root Rings	Hastelloy, Monel etc.
Tie Rods & Nuts	Stainless Steel, Hastelloy, Monel etc.
Anti-Snake Rings	Stainless Steel

Vacuum Performance

Whilst the standard bellows are not suitable for use under vacuum, they can be supplied with internal vacuum support rings to provide full vacuum performance. Vacuum support rings can be manufactured from Hastelloy, Titanium, Tantalum or PTFE encapsulated etc.

- Notes:
- Larger movements are available with more convolutions if required. These are not combined movements please refer to page 7.
 - Please refer to page 5 for temperature correction factors for spring rate.
 - As standard flange holes are threaded. Clearance holes are possible for certain sizes please contact us.
 - The maximum number of convolutions for this size is 6, please consult us for further information on these.
 - For operating temperature and pressure for more than 5 convolutions please contact us.

FluoroFlow FFB PTFE Bellows are manufactured from virgin or static dissipating paste extruded HiPerFlon® PTFE. They are manufactured using a unique process which ensures a uniform PTFE wall thickness and eliminates stress in the PTFE from the convolution process. These bellows are available with Heavy Duty "HD" or Extra Heavy Duty "XHD" liner.

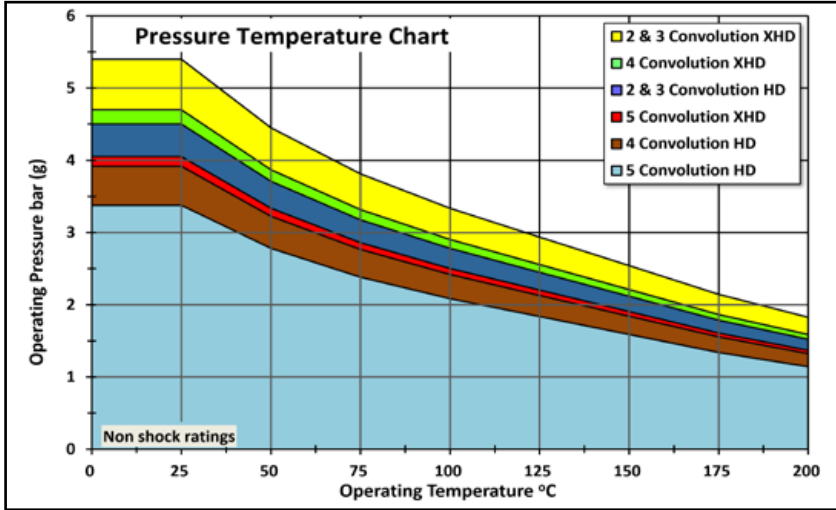

Dimensions and Movements ¹						Weight
Convolutions ⁴	Neutral Length [Inches]	Minimum Length [Inches]	Maximum Length [Inches]	Lateral +/- [Inches]	Angular +/- [degrees]	[lbs]
FFB 2	9.45	8.46	10.43	0.43	2	682
FFB 3	12.09	10.83	13.35	0.59	3	700
FFB 4	14.72	13.19	16.26	0.75	3	717
FFB 5	17.36	15.55	19.17	0.91	4	735

Spring Rates ² @ 68°F +/- 50%			
Axial Compression [lb / 1/8"]	Axial Extension [lb / 1/8"]	Lateral [lb / 1/8"]	Angular [inch-lbs / °]
2934	2220	5260	1522
1956	1475	3507	1009
1467	1106	2630	761
1173	885	2104	602

Materials	
Component	Materials
Bellows	Multi-ply Virgin PTFE to ASTM D4894 Type IV
Flanges	Carbon Steel to BS1501-161-430A / P265GH Typical
Paint	Ultra-High Temperature in Silver
Root Rings	Stainless Steel to 320S31 (316Ti)
Tie Rods & Nuts	Carbon Steel Grade 8.8 Zinc Plated
Limit Sleeves	Stainless Steel to ASTM A312 Gr. 304/304L

Flanges		
	ASME Class 150 Series A	ASME Class 150 Series B
Raised Face Ø	40.25"	38.25"
Bolt Circle Ø	42.75"	39.75"
Flange Ø max	50.13"	46.00"
Bolt Holes ³ [No x Thread]	32 x 1.1/2" UNC	44 x 7/8" UNC
Thickness	1.77"	
Effective Area	1041.6" ²	

Options	
Bellows	Paste Extruded Static-Dissipating ASTM D4895
Flanges	Stainless Steel, Hastelloy, Low Temperature Steels etc.
Root Rings	Hastelloy, Monel etc.
Tie Rods & Nuts	Stainless Steel, Hastelloy, Monel etc.
Anti-Snake Rings	Stainless Steel

Vacuum Performance

Whilst the standard bellows are not suitable for use under vacuum, they can be supplied with internal vacuum support rings to provide full vacuum performance. Vacuum support rings can be manufactured from Hastelloy, Titanium, Tantalum or PTFE encapsulated etc.

Notes:

1. Larger movements are available with more convolutions if required. These are not combined movements please refer to page 7.
2. Please refer to page 5 for temperature correction factors for spring rate.
3. As standard flange holes are threaded. Clearance holes are possible for certain sizes please contact us.
4. The maximum number of convolutions for this size is 6, please consult us for further information on these.
5. For operating temperature and pressure for more than 5 convolutions please contact us.

FluoroFlow FFB PTFE Bellows are manufactured from virgin or static dissipating paste extruded HiPerFlon® PTFE. They are manufactured using a unique process which ensures a uniform PTFE wall thickness and eliminates stress in the PTFE from the convolution process. These bellows are available with Heavy Duty “HD” or Extra Heavy Duty “XHD” liner.

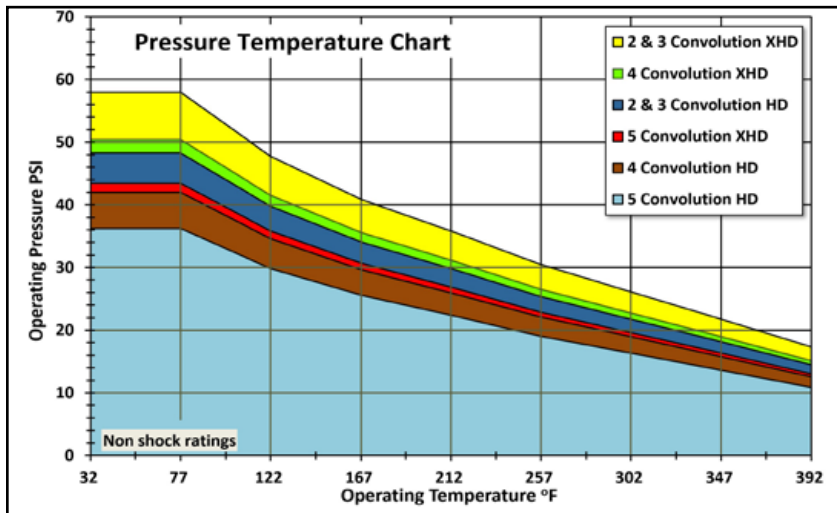

Dimensions and Movements ¹						Weight
Convolutions ⁴	Neutral Length [Inches]	Minimum Length [Inches]	Maximum Length [Inches]	Lateral +/- [Inches]	Angular +/- [degrees]	[lbs]
FFB 2	10.28	9.29	11.26	0.43	2.0	1126
FFB 3	12.83	11.57	14.09	0.59	2.5	1140
FFB 4	15.39	13.86	16.93	0.75	3.0	1152
FFB 5	17.95	16.14	19.76	0.91	3.5	1166

Spring Rates ² @ 68°F +/- 50%			
Axial Compression [lb / 1/8"]	Axial Extension [lb / 1/8"]	Lateral [lb / 1/8"]	Angular [inch-lbs / °]
3444	2577	6128	1770
2296	1718	4086	1168
1722	1288	3064	894
1378	1031	2451	699

Materials	
Component	Materials
Bellows	Multi-ply Virgin PTFE to ASTM D4894 Type IV
Flanges	Carbon Steel to BS1501-161-430A / P265GH Typical
Paint	Ultra-High Temperature in Silver
Root Rings	Stainless Steel to 320S31 (316Ti)
Tie Rods & Nuts	Carbon Steel Grade 8.8 Zinc Plated
Limit Sleeves	Stainless Steel to ASTM A312 Gr. 304/304L

Flanges		
	ASME Class 150 Series A	ASME Class 150 Series B
Raised Face Ø	47.00"	44.50"
Bolt Circle Ø	49.50"	46.12"
Flange Ø max	58.00"	54.00"
Bolt Holes ³ [No x Thread]	36 x 1.1/2" UNC	48 x 1"UNC
Thickness	1.96"	
Effective Area	1658.5" ²	

Options	
Bellows	Paste Extruded Static-Dissipating ASTM D4895
Flanges	Stainless Steel, Hastelloy, Low Temperature Steels etc.
Root Rings	Hastelloy, Monel etc.
Tie Rods & Nuts	Stainless Steel, Hastelloy, Monel etc.
Anti-Snake Rings	Stainless Steel

Vacuum Performance
Whilst the standard bellows are not suitable for use under vacuum, they can be supplied with internal vacuum support rings to provide full vacuum performance. Vacuum support rings can be manufactured from Hastelloy, Titanium, Tantalum or PTFE encapsulated etc.

- Notes:
- Larger movements are available with more convolutions if required. These are not combined movements please refer to page 7.
 - Please refer to page 5 for temperature correction factors for spring rate.
 - As standard flange holes are threaded. Clearance holes are possible for certain sizes please contact us.
 - The maximum number of convolutions for this size is 6, please consult us for further information on these.
 - For operating temperature and pressure for more than 5 convolutions please contact us.

Armoured FluoroFlow FFAB PTFE ASME 150 Bellows are available in 2 lengths for most sizes as standard and manufactured from virgin HiPerFlon® PTFE combined with a multi-layered austenitic stainless steel shell to provide high pressure performance outside the range of conventional PTFE bellows. This range is designed to the EJMA international standard.

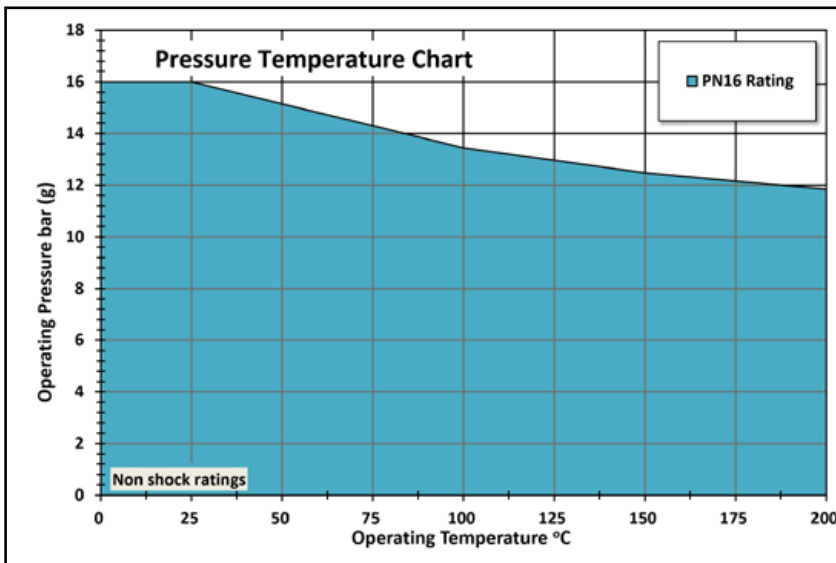

Materials	
Component	Materials
Bellows Liner	Paste Extruded Virgin PTFE to ASTM D4895
Bellows Shell	Stainless Steel to 321S31 /321 /1.4541
Flanges	Carbon Steel to S235JRG2 / RSt 37.2
Paint on CS flanges	Zinc Epoxy Primer, Colour Grey

Options	
Bellows Liner	Paste Extruded Static-Dissipating PTFE to ASTM D4895
Bellows Shell	Hastelloy & other Exotic Materials
Flanges	Stainless Steel, Exotics etc.
Bolt Holes	Threaded Holes UNC or Metric
Tie Rods	Available as an option

Dimensions and Movements								Weight
NB	Neutral Length [Inches]	Minimum Length [Inches]	Maximum Length [Inches]	Lateral +/- [Inches]	Angular +/- [Degrees]	Spring Rate [lb / 1/8"] ¹	Effective Area [Inches ²]	[lbs]
1.1/2"	5.12	4.76	5.47	0.04	3.0	131	4.31	6.6
2"	4.92	4.57	5.28	0.04	3.0	132	6.54	11.0
2.1/2"	5.31	4.96	5.67	0.04	2.0	143	9.15	15.4
3"	5.12	4.72	5.51	0.04	2.0	154	13.19	17.6
4"	6.30	5.91	6.69	0.04	2.0	214	21.44	26.4
5"	6.89	6.46	7.32	0.04	2.0	278	31.12	30.8
6"	6.50	6.06	6.93	0.04	1.0	378	43.25	37.4
8"	7.09	6.61	7.56	0.04	1.0	505	69.44	59.4
10"	7.87	7.32	8.43	0.04	1.0	640	104.94	83.6
12"	7.68	7.01	8.35	0.04	1.0	565	145.55	129.8
14"	6.89	6.18	7.60	0.04	1.0	732	171.74	171.6
20"	8.66	7.68	9.65	0.04	1.0	761	334.65	316.8

Notes:

1. Spring rates are for both axial extension and compression.
2. Tie rods are not supplied as standard but are available, including with spherical washers as required.
3. For vacuum performance information please refer to page 33.

FluoroFlow FFAB Armoured PTFE Bellows 1.1/2" - 16" 232 PSI ASME 150 Long Series



Armoured FluoroFlow FFAB PTFE ASME 150 Bellows are available in 2 lengths for most sizes as standard and manufactured from virgin HiPerFlon® PTFE combined with a multi-layered austenitic stainless steel shell to provide high pressure performance outside the range of conventional PTFE bellows. This range is designed to the EJMA international standard.

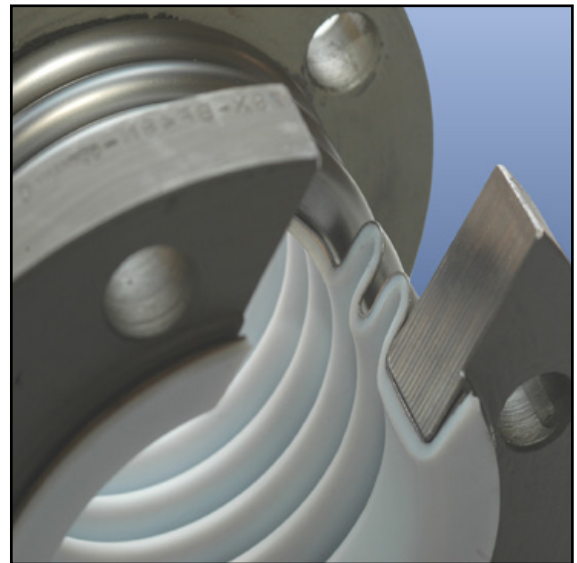
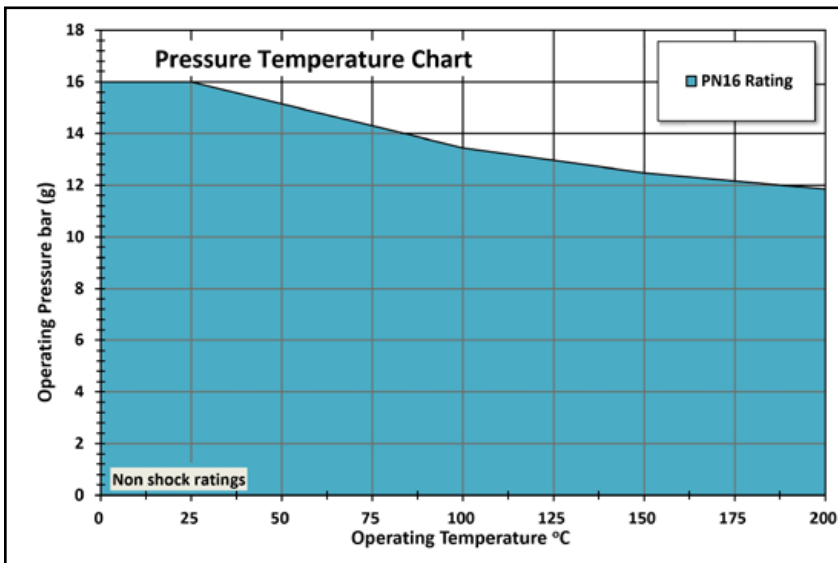

Vacuum Performance for Armoured FFAB Bellows (All types pages 32-34)

Temperature / Vacuum	1.1/2" - 4"NB	5"NB	6"NB	8"NB	10"NB	12"NB	14"NB	16"NB	20"NB
68°F / PSI (g)	Full vac.	Full vac.	Full vac.	-14.21	-13.77	-12.90	-11.89	0.0	0.0
212°F / PSI (g)	-14.5	-14.5	-14.5	-13.77	-12.61	-11.16	-9.28	0.0	0.0
356°F / PSI (g)	Full vac.	-14.0	-13.7	-12.76	-11.16	-9.28	-6.81	0.0	0.0

Dimensions and Movements

Dimensions and Movements								Weight
NB	Neutral Length [Inches]	Minimum Length [Inches]	Maximum Length [Inches]	Lateral +/- [Inches]	Angular +/- [Degrees]	Spring Rate [lb / 1/8"] ¹	Effective Area [Inches ²]	[lbs]
1.1/2"	8.86	8.27	9.45	0.04	3.0	99	4.22	6.6
2"	8.46	7.87	9.06	0.04	3.0	103	6.43	11
2.1/2"	8.46	7.76	9.17	0.04	2.0	153	8.84	17.6
3"	8.66	7.91	9.41	0.04	2.0	144	13.02	22
4"	10.24	9.41	11.06	0.04	2.0	128	21.24	28.6
5"	10.63	9.72	11.54	0.04	2.0	169	30.85	35.2
6"	11.81	10.79	12.83	0.04	1.0	154	43.40	37.4
8"	12.80	11.50	14.09	0.04	1.0	216	69.05	66.0
10"	13.00	11.65	14.33	0.04	1.0	268	104.94	88.0
12"	13.78	12.20	15.35	0.04	1.0	241	145.55	134.2
14"	12.40	10.67	14.13	0.04	1.0	345	171.74	176.0
16"	13.19	11.30	15.08	0.04	1.0	318	222.74	250.8

Notes:

1. Spring rates are for both axial extension and compression.
2. Tie rods are not supplied as standard but are available, including with spherical washers as required.

Armoured FluoroFlow FFAB PTFE ASME 300 Bellows are manufactured from virgin HiPerFlon® PTFE combined with a multi-layered austenitic stainless steel shell to provide high pressure performance outside the range of conventional PTFE bellows. This range is designed to the EJMA international standard.

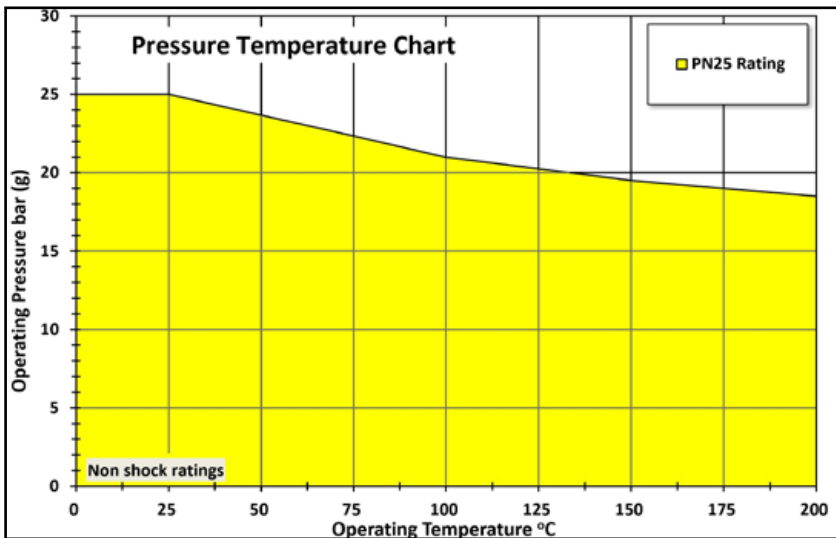

Materials	
Component	Materials
Bellows Liner	Paste Extruded Virgin PTFE to ASTM D4895
Bellows Shell	Stainless Steel to 321S31 /321 /1.4541
Flanges	Carbon Steel to S235JRG2 / RSt 37.2
Paint on CS flanges	Zinc Epoxy Primer, Colour Grey

Options	
Bellows Liner	Paste Extruded Static-Dissipating PTFE to ASTM D4895
Bellows Shell	Hastelloy & other Exotic Materials
Flanges	Stainless Steel, Exotics etc.
Bolt Holes	Threaded Holes UNC or Metric
Tie Rods	Available as an option

Dimensions and Movements								Weight
NB	Neutral Length [mm]	Minimum Length [mm]	Maximum Length [mm]	Lateral +/- [mm]	Angular +/- [Degrees]	Spring Rate [N/mm] ¹	Effective Area [mm ²]	ASME [lbs]
1.1/2"	10.24	9.69	10.79	0.04	3.0	189	4.06	15.4
2"	9.45	8.86	10.04	0.04	3.0	197	6.22	17.6
2.1/2"	9.06	8.43	9.69	0.04	2.0	196	8.77	26.5
3"	8.86	8.23	9.49	0.04	2.0	175	12.88	33.0
4"	8.66	8.00	9.33	0.04	2.0	200	21.05	55.0
5"	11.81	11.02	12.60	0.04	2.0	254	30.43	77.0
6"	11.61	10.83	12.40	0.04	1.0	291	42.56	94.6
8"	9.06	8.54	9.57	0.04	1.0	535	68.73	134.5
10"	13.00	11.93	14.06	0.04	1.0	445	104.16	202.4
12"	13.58	12.28	14.88	0.04	1.0	426	143.58	299.2
14"	13.19	11.81	14.57	0.04	1.0	472	170.04	374.8
16"	13.78	12.32	15.24	0.04	1.0	613	221.96	460.8
20"	11.81	10.55	13.07	0.04	1.0	782	337.13	639.3

Notes:

1. Spring rates are for both axial extension and compression.
2. Tie rods are not supplied as standard but are available, including with spherical washers as required
3. For vacuum performance please refer to page 33.

Bellows Specifier Cut Sheet



PTFE Bellows need to be specified accurately to perform safely and have a long life. Beyond the basics of nominal bore size, media, temperature and pressure, the movements required from the bellows are critical. The individual data sheets for each bellows size provide the data for our standard products. If this does not suit your application then please contact us with the information below and allow us to help.

Customer Name Media

Operational Information

Minimum Operating Temperature °F Maximum Operating Temperature °F
 Minimum Operating Pressure PSI (g) Maximum Operating Pressure PSI (g)
 Vacuum PSI (g) Bellows NB "

Mechanical Requirements

Neutral Length "
 Movements Axial " Lateral " Angular °
 Are the movements ever combined at the same time? If so please identify the maximum combined movements.
 Combined Movements Axial " Lateral " Angular °

Bellows Type

Armoured PTFE Bellows
 Standard 3 Convolution Bellows or Number of Convolutions Signifies standard product
HiPerflon® PTFE
 HiPerFlon® Virgin PTFE HiPerFlon® Static-Dissipating PTFE

Flange Material

Carbon Steel Stainless Steel Other

Flange Drillings

ASME B16.5 Class 150 ASME B16.5 Class 300 Other

Tie Rods

Carbon Steel, Zinc Plated Stainless Steel Other

Root Rings

316Ti Stainless Steel Hastelloy Other

Vacuum Support Rings

Stainless Steel PTFE Lined Hastelloy Other

Options

Smoothbore Sleeve Safety Shield (Strongly Recommended)

Certification

EN10204 Type 2.2 EN10204 Type 3.1

Other Remarks
 Form CRP - QA05



Distributed By:

ChemValve-Schmid Americas L.L.C.
34990 Emerald Coast Parkway
Suite 367
Destin, FL 32541
USA
850-842-0045

This information is for general purposes only and we believe the literature to be accurate. Nothing contained herein is to be construed as a warranty or guarantee, express or implied, regarding any matter with respect to this product.